

Ultrasonic Flowmeter for Liquids

Portable or Stationary



measuring
•
monitoring
•
analyzing

DUC

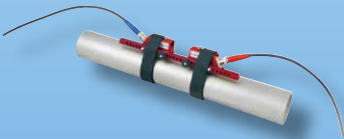

- Media: Ultrasonic Conducting Liquids
- Temperature Range: -40...300 °F
- Accuracy: up to 1%
- Flow Velocities: 0...± 98 ft/sec
- Pipe Sizes: 3/8" ...20 feet
- For Use with Common Pipe Materials, with Ultrasonic Conductive Properties, like Steel and Plastics
- Heat Quantity Measurement



KOBOLD companies worldwide:

AUSTRALIA, AUSTRIA, BELGIUM, BULGARIA, CANADA, CHINA, CZECHIA, FRANCE, GERMANY, GREAT BRITAIN, HUNGARY, INDIA, INDONESIA, ITALY, MALAYSIA, MEXICO, NETHERLANDS, PERU, POLAND, REPUBLIC OF KOREA, RUSSIA, SPAIN, SWITZERLAND, THAILAND, TUNISIA, TURKEY, USA, VIETNAM

KOBOLD Instruments, Inc.
1801 Parkway View Drive
Pittsburgh, PA 15205
Main Office:
1.800.998.1020
1.412.788.4890
info@koboldusa.com
www.koboldusa.com

Description

The KOBOLD DUC uses the effect of acceleration and deceleration of acoustic signals traveling in a moving liquid. Two ultrasonic clamp-on transducers are externally mounted on a pipe and produce an acoustic path. The transducers send and receive acoustic signals and the transit times, t_1 and t_2 , are measured by an electronic flow transmitter. The signal from transducer A towards transducer B is accelerated by the flow (shorter t_1). The return signal from transducer B to transducer A is decelerated by the flow (longer t_2). The difference between t_1 and t_2 , together with the path length L , can be used to determine the average flow velocity. This principle is known as the acoustic time-of-flight principle. The flow is calculated from the geometry data of the pipe and the flow velocity.

The DUC emits a coded signal pattern into the pipe. The received signals will be compared with the sent signals and only the signal pattern, which correlates with the original one, will be used for flow calculation (cross correlation based signal evaluation). The calculation of the flow is done with the integrated DSP (digital signal processor). Thus, the calculation has high sampling rates.

The DSP calculation of the time-of-flight is a pure digital transit time measurement. It is very precise, completely drift and maintenance free, and there is no need for recurring calibrations.

Applications Areas

- **Power Plants:** Cooling Water, District Heating, Pump Protection, Condensate and Boiler Feedwater Measurements
- **Water and Waste-Water Industry:** Treatment Plant Inflow, Treatment Plant Outflow, Drinking Water Networks, Verification of Water Meters, Pump Protection, Distribution and Consumption Measurements, Leakage Detection
- **Facility Management:** Hot and Cold Water, Cooling Systems and Air Conditioning Systems, Optimization of Energy Efficiency, Pump Control, Optimization of Heating and Air Conditioning
- **Chemical and Petrochemical Industry:** Crude Oil and Light Oil, Raw and Waste-water, Aggressive and Toxic Media, Measurement of Heat Carriers (e.g. Thermal Oils)
- **Food and Beverage:** Correct Hygienic Measurement of Media, Heat Volume Measurement in Energy Supply

Features

- Easy-to-read User Interface with LED Backlight, QVGA Display
- User Interface Control with 6 Buttons
- Quick-Mount-System with Space Bar for Ultrasonic Transducers, 1 MHz and 4 MHz
- AFC Compensation Algorithm: Compensates for Influences of Changing Media Temperatures
- Reynolds Compensation: Compensates for Influences of Media Viscosity
- Ultrasonic Transducers and Technology: Reduces Signal Echoes and Dispersion Effects, Having a Positive Effect on the Signal to Noise Ratio
- 2 Channel Operation, with Stationary Transmitter



Flow Transmitters

DUC-xP: Portable Flow Transmitter

Flow measurement, thermal output, and heat quantity measurement is possible for one measurement point with a pair of ultrasonic transducers in combination with a pair of PT100 temperature sensors. Other features of the DUC-xP transmitter are battery operation, integrated data logger, and a stable aluminum/ABS housing.

DUC-xF: Stationary 1-Channel Flow Transmitter



Flow measurement, thermal output, and heat quantity measurement is applicable for one measurement point in combination with one pair ultrasonic transducers and one pair PT100.



DUC-xF: Stationary 2-Channel Flow Transmitter



Flow measurement is applicable for one or two different measurement points with two pairs of ultrasonic transducers. DUC-xF 2-channel version supports different mathematical operations like $CH1+CH2$, $CH1-CH2$, $(CH1+CH2)/2$; due to the appliance of two mounted pairs of ultrasonic-transducers. Opposite mounting of 2 pairs of transducers on the same pipe will increase the accuracy of measurement, and a redundancy operation is possible where disruptive influences of gaseous flow profile will be compensated. Thermal output and heat quantity measurement is only supported in operation mode $(CH1+CH2)/2$.

DUC-W Standard Ultrasonic Transducers

The ultrasonic transducers are mounted onto the piping and transmit and receive the ultrasonic signals that are used in the flow transmitter to calculate the volumetric flow rate.

Ultrasonic Transducer DUC-Wx40 (4 MHz)		
Specifications		
Housing:	Red	 <p>DUC-WP40</p>
Pipe Diameters:	3/8"...4"	
Operating Temp:	-40...300 °F	
Protection:	IP 68 (for Stationary Transducer)	
Material:	PEEK/Aluminum	
		 <p>DUC-WF40</p>

Ultrasonic Transducer DUC-Wx10 (1 MHz)		
Specifications		
Housing:	Blue	 <p>DUC-WP10</p>
Pipe Diameters:	1-1/4"...16"	
Operating Temp:	-40...300 °F	
Protection:	IP 68 (for Stationary Transducer)	
Material:	PEEK/Aluminum	
		 <p>DUC-WF10</p>

Ultrasonic Transducer DUC-Wx05 (0.5 MHz)		
Specifications		
Housing:	Green	 <p>DUC-WP05</p>
Pipe Diameters:	8"...20 feet	
Operating Temp:	-40...300 °F (with Stainless Steel Strap) ¹⁾ -40...176 °F (with Textile Tightening Straps)	
Protection:	IP 68 (for Stationary Transducer)	
Material:	PEEK/Aluminum	
		 <p>DUC-WF05</p>

¹⁾ **Note:** stainless steel strap is only for one-time use



Measurement Accuracy for Each Channel

Pipe Size	Flow Velocity	Accuracy
3/8" ...1"	0...6.56 ft/sec	±0.164 ft/sec
	6.56...98.42 ft/sec	2.5% of Reading
1" ...2"	0...6.56 ft/sec	±0.098 ft/sec
	6.56...98.42 ft/sec	1.5% of Reading
2" ...12"	0...6.56 ft/sec	±0.065 ft/sec
	6.56...98.42 ft/sec	1% of Reading
8" ...20 feet	0...6.56 ft/sec	±0.065 ft/sec
	6.56...98.42 ft/sec	1% of Reading



Ultrasonic Flowmeter Model DUC

Technical Details: DUC-Mx

Specification	DUC-MF (Stationary)	DUC-MP (Portable)
Image		
Measuring Principle	Ultrasonic Time-of-Flight	
Physical Quantities	Volume Flow, Flow Velocity, Power	
Installation	Wall Mount	Portable
Counter	Heat Quantity, Volume	
Measuring Range	0...98.42 ft/sec (Bi-directional)	
Signal Damping	0 ... 100 s (Adjustable)	
Diagnostic Functions	Ultrasonic Velocity, Signal Strength, SNR, Signal Quality, Amplitude, Energy, Oscilloscope Function for Graphical Display and Evaluation of Signal	
Interface	Intuitive, via 8 Soft Keys, Easy-to-Read Display	
Menu Language Packages	EN/DE/FR, EN/ES/FR ¹⁾ EN/RU/CHN ¹⁾	
Flow Transmitter Units	Metric/US	
Outputs	2x4 ... 20 mA, 1x Pulse with 1 Channel/ 2x Pulse with 2 Channel, 1x Micro USB, 1x Relay Optional RS232/RS485 (RS485 Supports Modbus Communication)	2x4 ... 20 mA, 1x Pulse, 1x Micro USB, 1x Relay
Additional Inputs for Heat Measurement	2 x Pt 100	
Measuring Channels	1, Optional 2	1
Power Supply	90-240 V _{AC} , Optional 18-36 V _{DC}	Integrated Battery or 100 ... 240 V _{AC} Wide Range Power Supply
Battery Operation	-	Approx. 5 h
Integrated Data Storage	Optional as for DUC-MP	4 GB
Saved Data	Optional as for DUC-MP	Measuring and Diagnostic Value Counter
Data Format	Optional as for DUC-MP	Text Format (CSV) Directly Importable into all Popular Programs like MS Office, MS Works, etc.
Memory Cycle	-	Adjustable, 1 s up to 24 h
Protection	IP65	IP40
Cable Connections	Screw Terminals	BNC-Connection
Housing	ABS	Aluminum, ABS
Operating Temperature	-4...140 °F	
Dimensions	10.24" x 9.45" x 4.73" (W, H, D)	10.43" x 7.48" x 2.76" (W, H, D)
Weight	2.87 lbs	3.31 lbs
Display	QVGA (320 x 240), Black and White, Adjustable Backlight	
Measuring Modes ²⁾	CH1, CH2, CH1+CH2, CH1-CH2, (CH1+CH2)/2	-

¹⁾ for 1-channel operation only ²⁾ for 2-channel operation only

General Specifications for Ultrasonic Transducers

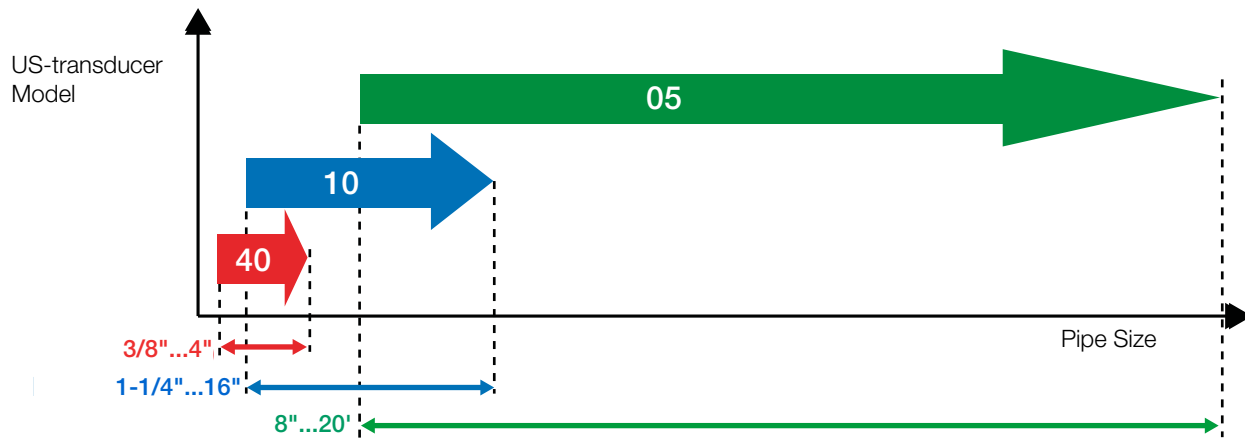

Ultrasonic Transducers for Transit Time Measurement

Model	Description	Media Temperature	Pipe Sizes
DUC-WP40		-40...300 °F	3/8" ...4"
DUC-WP10			1-1/4" ...16"
DUC-WP05			8" ...20'
DUC-WF40		-40...300 °F	3/8" ...4"
DUC-WF10			1-1/4" ...16"
DUC-WF05			8" ...20'

Mounting Arrangement of the Ultrasonic Transducer

Mounting in V-mode (Standard)

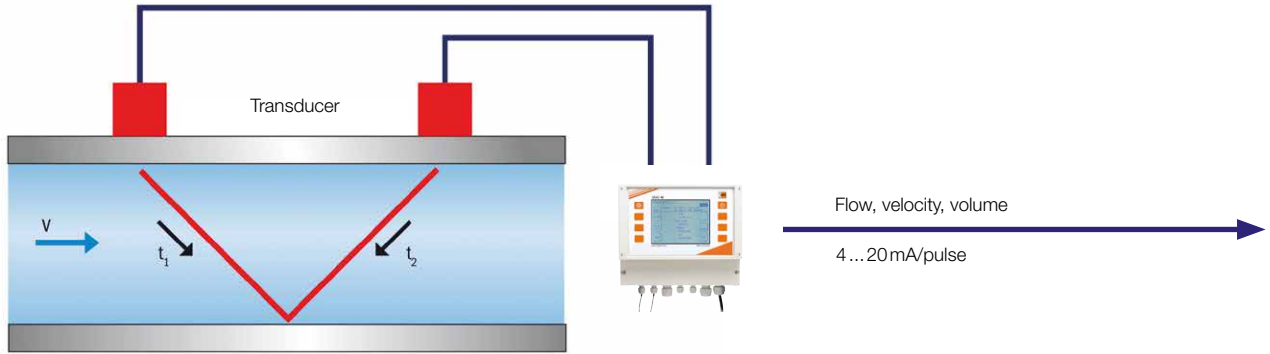

Mounting in Z-mode (Applicable for Large Pipe Dimensions or High Acoustic Damping)

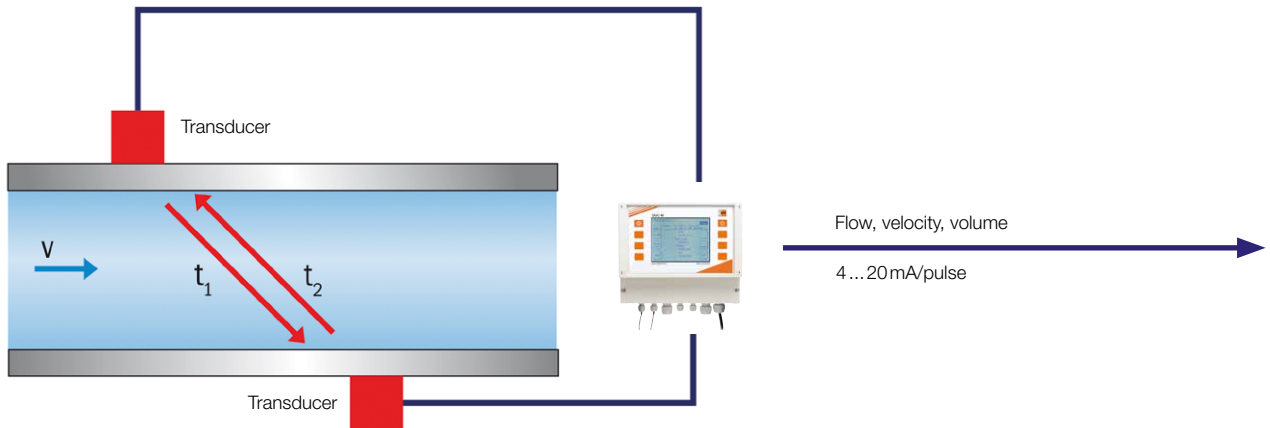

Mounting in W-mode (for Pipe Dimensions < 1-1/4")

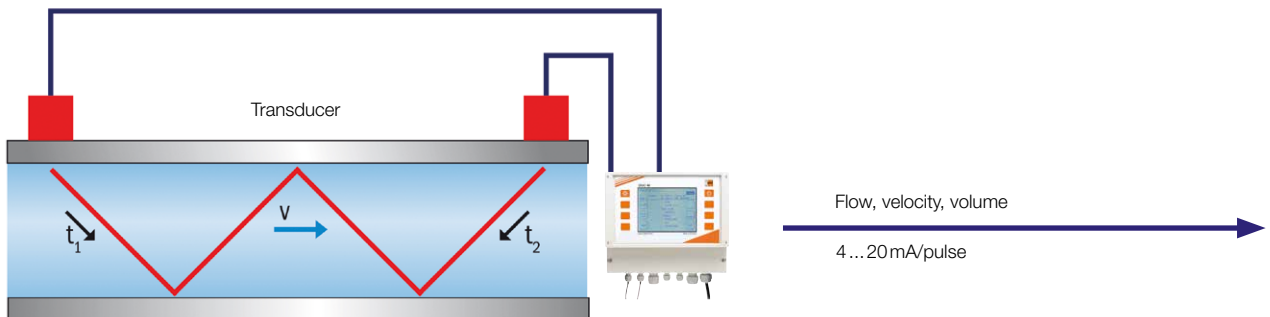

Measuring Mode: 2-Channel System

Simultaneous Measurement at 2 Different Measurement Points with Two Pairs of Ultrasonic Transducers

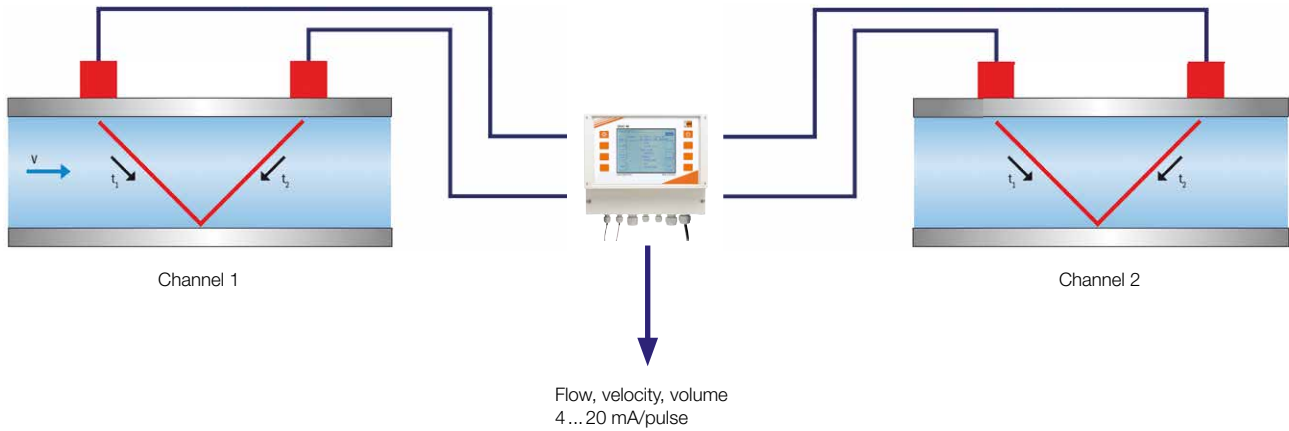

Simultaneous Measurement with Two Pairs of Ultrasonic Transducers at One Common Metering Point
 (Compensation of Cross-flow Effect on Measurement, Redundancy Operation and Higher Accuracy)

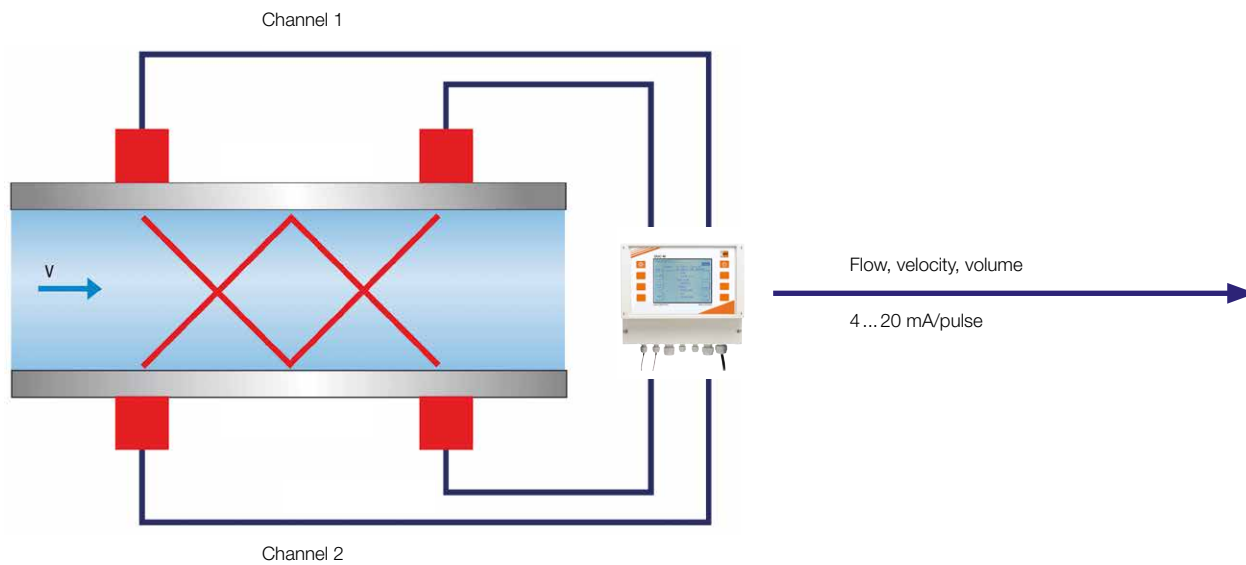

Measurement of Heat Quantity

The KOBOLD DUC-M is more than a flowmeter. Together, with external temperature sensors, it can also measure the heat transfer of your media. Only two optional Pt100 have to be connected to the DUC-MF for measuring feed/return temperatures (RTD 1/RTD 2) within the heating circuit. The measured temperature difference and the measured flow Q can then be used to calculate the thermal output and the heat quantity.

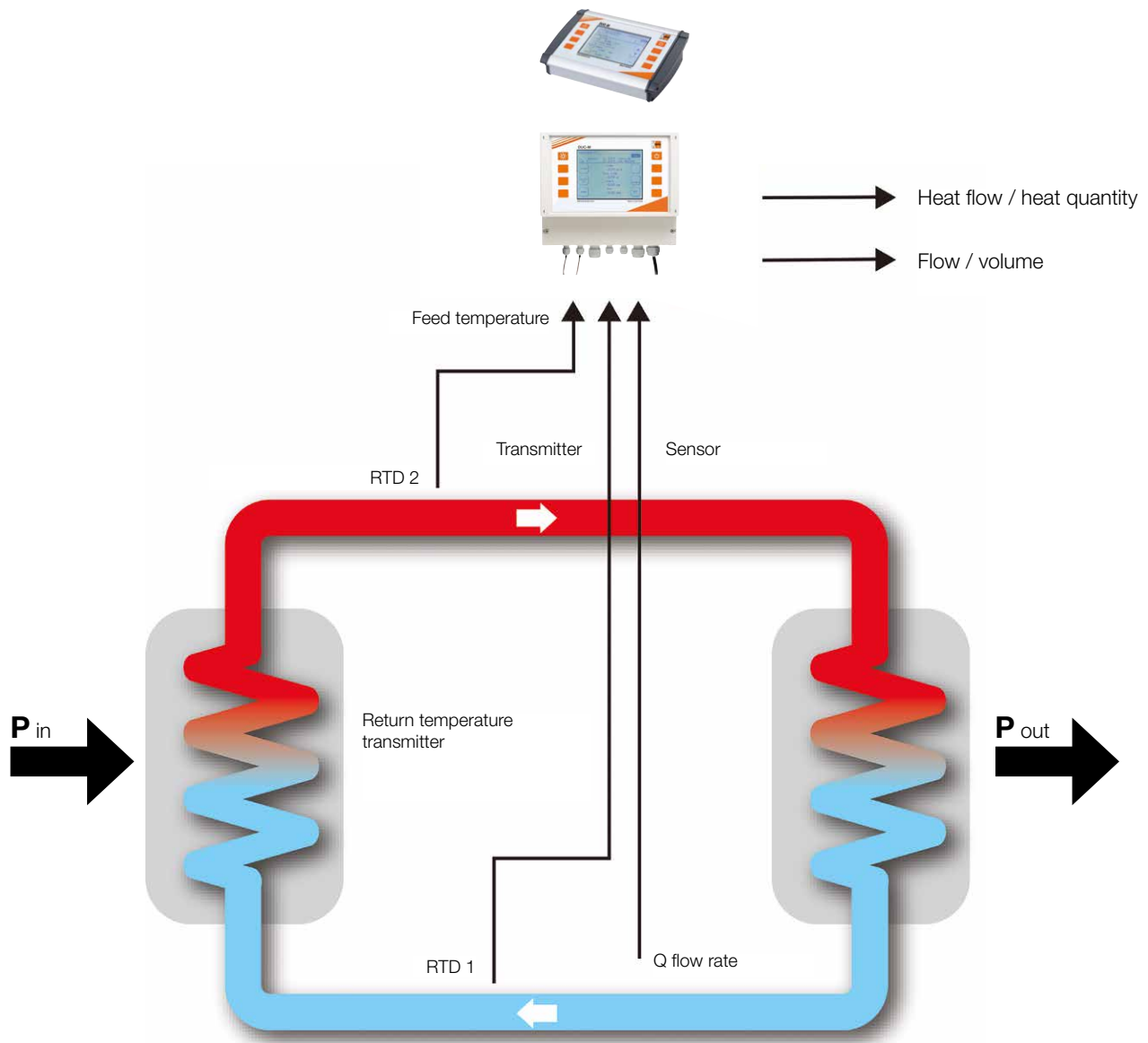



Order Details Transmitter (Example DUC-M F 1 0 0 D R2)

Model	Version	Channel	Supply	Ex-Approval	Language Packages	Options ²⁾
DUC-M..	..F.. = Stationary	..1.. = 1-channel ..2.. = 2-channel	..0.. = 90 ... 240 V _{AC} ..7.. = 18 ... 36 V _{DC}	..0.. = None ..E.. = ATEX Exd (Suitable for Zone 1 and 2) (on Request)	..D.. = EN/DE/FR ..S.. = EN/ES/FR ¹⁾ ..C.. = EN/RU/CHN ¹⁾	..00 = None ..R2 = RS232 ..R4 = RS485 ..RL = Data Logger
	..P.. = Portable	..1.. = 1-channel	..0.. = 100 ... 240 V _{AC}	..0.. = None		..00 = None

¹⁾ Only with 1-channel

²⁾ Combination of option R2 with RL or option R4 with RL can be ordered

Order Details Transducer (Example DUC-W F 40 0 10)

Model	Version	Frequency (NW)	Ex-Approval	Cable Length
DUC-W..	..F.. = Stationary	..40.. = 4 MHz (3/8" ... 4") ..10.. = 1 MHz (1-1/4" ... 16") ..05.. = 0.5 MHz (8" ... 20")	..0.. = None ..E.. = ATEX Exd (Suitable for Zone 1 and 2) ^{1) 2)}	..10 = 10 meter (32.8 feet) ..20 = 20 meter (65.6 feet) ..30 = 30 meter (98.4 feet) ..40 = 40 meter (131.2 feet) ..50 = 50 meter (164.0 feet) ..XX ³⁾ = Custom Length
	..P.. = Portable		..0.. = None	..03 ⁴⁾ = 3 meter (9.8 feet)

¹⁾ On Request ²⁾ Not for PVC Transducers ³⁾ Max. length 250 meters (820 feet) ordered in multiples of 10 meters only

⁴⁾ If the transducer is ordered as a spare part, the cable is not included in the scope of delivery

Delivery Scope for Portable Transmitter

The Following Accessories are Included:

1. Hard-shell Carrying Case
2. Operating Manual on CD, Quickstart Printed
3. Analog Output Cable Mini DIN, Crocodile Clips 0.5 m
4. Relay / Pulse Output Cable Mini DIN Crocodile Clips, 0.5 m
5. USB Cable
6. Signal Cable (1 Pair), BNC-connection, 3 m
7. Measuring Tape



Delivery Scope for Transducer (Portable and Stationary)

The Following Accessories are Included:













1. Mounting Rail (not for DUC-Wx05)
2. Coupling Foil for Stationary, Ultrasonic Coupling Gel for Portable Device
3. Suitable Mounting Accessories, such as Strap or Chains, Depending on the Transducer Type





Ultrasonic Flowmeter Model DUC

Order Details: Accessories/Spare Parts (Example DUC-Z F P1)

Model	Version	Description
DUC-Z..	..F.. = Stationary	<p>..KG = Ultrasonic Coupling Gel, Tube, 0.75 oz </p> <p>..MS = Mounting Rails Suitable for Transducer DUC-WF10 (Max. 16"), Max. 302 °F </p> <p>..PT = PT100, Surface Contact, 1 Pair, 5 m, includes SS Strap up to 36"</p> <p>..P1 = PT100, Surface Contact, 1 Pair, 10 m, Includes SS Strap up to 36"</p> <p>..P2 = PT100, Surface Contact, 1 Pair, 20 m, includes SS Strap up to 36" </p> <p>..WK = Factory Calibration 1 MHz or 4 MHz, 5-point on Pipe Size 2"</p> <p>..WR = Factory Recalibration 1 MHz or 4 MHz 5-point on Pipe Size 2"</p> <p>..10 = Coupling Foil, 2 Pair for DUC-WF10 </p> <p>..21 = Coupling Foil, 2 Pair for DUC-WF40</p> <p>..05 = Coupling Foil, 1 Pair for DUC-WF05</p> <p>..SB = Short Mounting Rails (Spacer Short Bar) Suitable for DUC-WF40, Max. 302 °F </p> <p>..EB = Stainless Steel Strap (1 pair) Suitable for Ultrasonic Transducer DUC-WF40, DUC-WF10 (Max. 16")</p> <p>..BE = Stainless Steel Strap (1 pair) Suitable for Ultrasonic Transducer DUC-WF05 </p> <p>..DE = Venting Unit for Gaseous Liquids, Pipe Connection Max. 1"</p>
		<p>..KG = Ultrasonic Coupling Gel, Tube, 0.75 oz </p> <p>..MS = Mounting Rails Suitable for Transducer DUC-WP10 (Max. 16"), Max. 302 °F </p> <p>..SB = Short Mounting Rails (Spacer Short Bar) Suitable for DUC-WP40, Max. 302 °F </p> <p>..MK = Clamping Chains (1 pair) Suitable for Transducer DUC-WP10 (Max. 16"), Max. 302 °F </p> <p>..BT = Textile Tightening Straps Suitable for Transducer DUC-WP05, Max. 176 °F </p> <p>..PT = PT100, 1 Pair, Mini DIN, 5 m, includes SS Strap up to 36" </p> <p>..WK = Factory Calibration 1 MHz or 4 MHz 5-point on Pipe Size 2"</p> <p>..WR = Factory Recalibration 1 MHz or 4 MHz 5-point on Pipe Size 2"</p>
	..U..	<p>..WD = Wall Thickness Gauge (Universal) <i>Technical Details: See Description DUC-ZUWD on Pg 11</i> </p>

Description: DUC-ZUWD

With the DUC-ZUWD pipe wall thickness gauge, precise and reliable measurements are delivered in a matter of minutes. Switch it on, enter your pipe data, and press the transducer onto your pipe, that's it.

The DUC-ZUWD determines the thickness of a structure or a pipe by accurately measuring the time required for an ultrasonic signal to travel through the thickness of the material, reflect from the back or inside surface, and be returned to the transducer. The measured two-way transit time, together with the specific speed of sound of your material, is used to accurately measure the wall thickness. The resolution is 0.1 mm!

The light-weight and rugged DUC-ZUWD is the perfect instrument for harsh environments within the process industry and is also a reliable and useful accessory for your DUC clamp-on ultrasonic flowmeter.

The long-life battery mode gives you the independence you need for your measurements. The integrated calibration sample ensures the best possible accuracy and high repeatability.



Technical Details

- Measuring Principle:** Ultrasonic Transit Time
- Measuring Range:** 0.03" ...3.14" (Steel)
- Accuracy:** ±(0.5 % of Thickness + 0.0016")
- Operating Temperature:** -4...158 °F
- Ultrasonic Transducers:** 7 MHz
- Supported Materials:** All Common Pipeline Materials, Sound Conductive, e.g. PVC, PE, Steel, Copper, etc.)
- Display:** 128x64 LCD with Backlight
- Resolution:** 0.1 mm
- Measuring Units:** Metric and US
- Languages:** DE, GB, IT, FR, ES
- Housing Material:** Aluminum
- Power Supply:** 2x Mignon Type AA 1.5V
- Dimensions:** 5.20" x 3.00" x 1.26" (HxWxD)
- Weight:** 0.76 lbs





Ultrasonic Flowmeter Model DUC

Dimensions

Transmitter DUC-MF (Stationary)
Front



Transducers DUC-WF (Stationary)

4 MHz

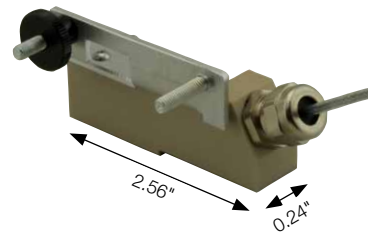

Side

Top

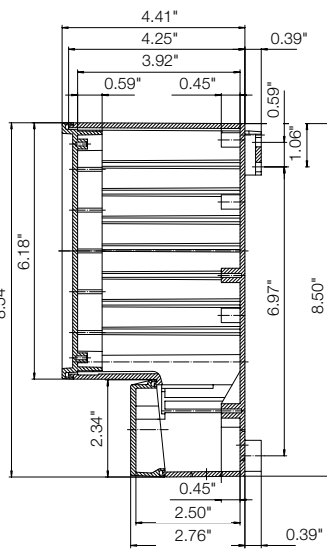

Front

Bottom

Bottom

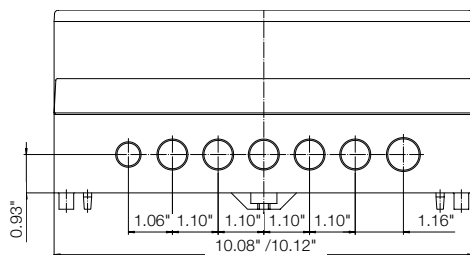

1 MHz

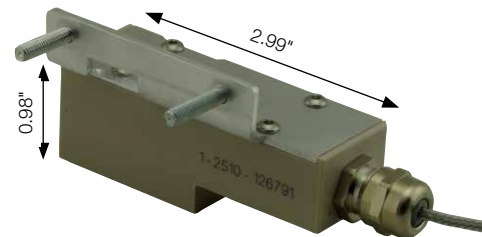

0.5 MHz

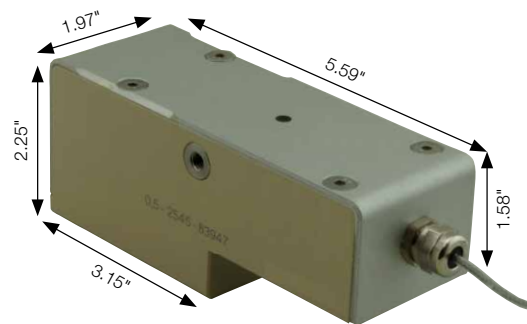

Weights

Model		Weight (lbs.)
Tranducer DUC-MF		2.87
Tranducer DUC-WF	4 MHz	0.10
	1 MHz	0.11
	0.5 MHz	0.22

Dimensions

Transmitter DUC-MP (Portable)



Transducers DUC-WP (Portable)

4 MHz

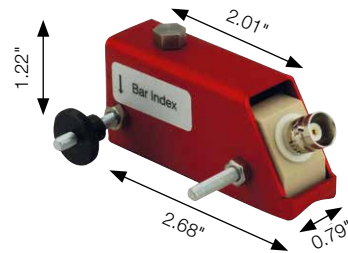

Backside of Aluminum Body

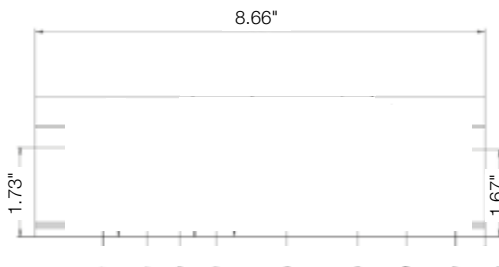

1 MHz

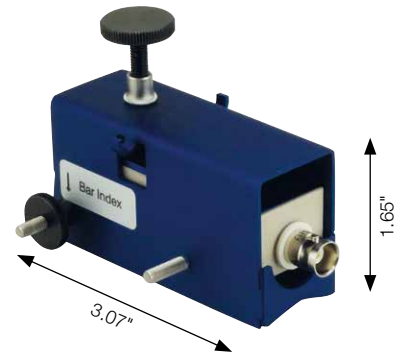

Sideview of Aluminum Body, Including Cover Plate

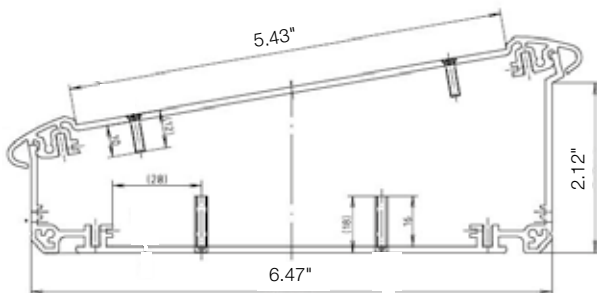

0.5 MHz

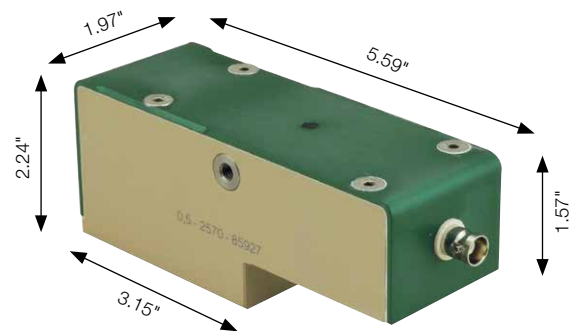

Weights

Model		Weight (lbs.)
Tranducer DUC-MP		3.31
Tranducer DUC-WP	4 MHz	0.10
	1 MHz	0.11
	0.5 MHz	0.22