



---

**Instruction Manual**

---

**FIXED TYPE ULTRASONIC  
FLOWMETER (FSV-2)  
COMMUNICATION  
FUNCTIONS**

**TYPE: FSV-2**

---

Note: MODBUS® is the trade mark or registered trade mark of AEG Schneider Automation International.

NOTICE

1. Exemption items from responsibility

The contents of this document may be changed in the future without prior notice.

We paid the utmost care for the accuracy of the contents. However, we are not liable for direct and indirect damages resulting from incorrect descriptions, omission of information, and use of information in this document.

# CONTENTS

1.	COMMUNICATION FUNCTIONS .....	1
1.1	General .....	1
2.	SPECIFICATIONS .....	3
2.1	Communication Specifications.....	3
3.	CONNECTION.....	4
3.1	Communication Terminal Allocation.....	4
3.2	Wiring.....	5
4.	SETTING OF COMMUNICATION CONDITION .....	6
4.1	Set Items .....	6
4.2	Setting operation method.....	6
5.	MODBUS COMMUNICATION PROTOCOL .....	7
5.1	General .....	7
5.2	Composition of Message .....	8
5.3	Response of Slave Station .....	9
5.4	Function Code .....	10
5.5	Calculation of Error Check Code (CRC-16) .....	11
5.6	Transmission Control Procedure .....	12
5.7	FIX Processing (Cautions in data write).....	14
6.	DETAILS OF MESSAGE.....	15
6.1	Read-out of Word Data [Function code:03 <sub>H</sub> ] .....	15
6.2	Read-out of Read-out Only Word Data [Function code:04 <sub>H</sub> ].....	17
6.3	Write-in of Word Data [Function code:06 <sub>H</sub> ] .....	19
6.4	Write-in of continuous word data [Function code:10 <sub>H</sub> ].....	20
7.	ADDRESS MAP AND DATA FORMAT .....	22
7.1	Data Format .....	22
7.2	Address Map.....	24
8.	M-FLOW COMMUNICATION PROTOCOL .....	31
8.1	General .....	31
8.2	Message Configuration.....	32
8.3	Error Check .....	32
8.4	Function Code Table .....	33
8.5	Error Code Table .....	33
9.	PC LOADER SOFTWARE IN CD SUPPLIED WITH THE MAIN UNIT .....	34
9.1	Copyright of This Software .....	34
9.2	Outline .....	34
9.3	PC to Be Used .....	34
9.4	Installing of Software .....	35
9.5	Startup Method .....	38
9.6	Structure of Function.....	42
9.7	Process Setting .....	43
9.8	Range Setting .....	45
9.9	Total Setting .....	47
9.10	Status Output Setting.....	49
9.11	Display Setting .....	51

9.12	System Setting.....	53
9.13	Measurement.....	54
9.14	Transit Time Difference Measurement .....	56
9.15	RAS.....	61
9.16	Maintenance .....	62
9.17	PV.....	64
9.18	End .....	66
9.19	Uninstalling of Software .....	66
10.	TROUBLESHOOTING.....	67

# 1. COMMUNICATION FUNCTIONS

## 1.1 General

- This instrument provides a communication function by RS-485 interface, by which it can transmit and receive data to and from host computer, programmable controller, graphic display panel, etc.
- When using the RS-485 interface, the communication system consists of master station and slave stations. Up to 31 slave stations (this instrument) can be connected per master station.  
Note that, because the master station can communicate with only one slave station at a time, a party to communicate with must be specified by the “Station No.” set at each slave station.
- In order that the master station and slave station can communicate, the format of the transmit/receive data must coincide. With this instrument, communication data format is determined by the MODBUS protocol and M-Flow protocol (our M-flow [Type: FLR]).
- Please use an RS-232C ⇔ RS-485 converter in case of designating a personal computer or other devices which have an RS-232C interface as a master station.

[RS-232C ⇔ RS-485 converter] (recommended article)

Type: K3SC-10 (isolated type)/OMRON Corporation

System configuration (when using the RS-485 interface)

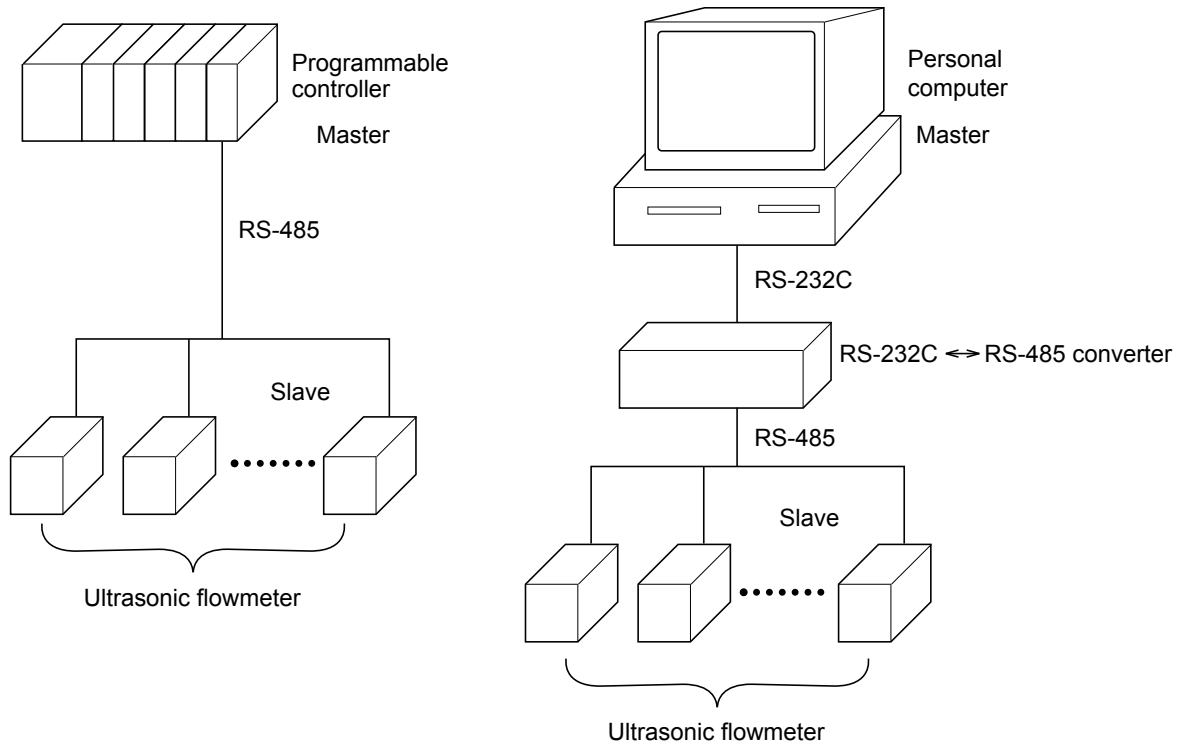

[Note] MODBUS<sup>®</sup> is the registered trademark of Schneider Electric.

**Caution:**

When using the RS-232C ↔ RS-485 converter, pay attention to cable connection between the converter and master station. If the cable is not connected correctly, the master station and slave station cannot communicate. In addition, be careful about communication settings such as baud rate and parity set for the converter.

## 2. SPECIFICATIONS

### 2.1 Communication Specifications

Item	Specification	
Electrical specification	Based on EIA RS-485	
Transmission system	2-wire, semi-duplicate	
Synchronizing system	Start-stop synchronous system	
Connection format	1 : N (RS-485)	
Number connectable units	Up to 31 units (RS-485)	
Transmission distance (total extension)	1,000 m max. (RS-485)	
Transmission speed	9600, 19200, 38400 bps	
Data format	Data length	8 bits
	Stop bit	1 bit
	Parity	none, even, odd (selectable)
Isolation	Functional isolation between transmission circuit and ground (withstand voltage : 500V AC)	

#### 2.1.1 Communication protocol

(1) MODBUS protocol

Item	Specification
Transmission code	HEX value (MODBUS RTU mode)
Error detection	CRC-16

(2) M-Flow protocol (our M-Flow [Type: FLR])

Item	Specification
Transmission code	ASCII
Error detection	LRC (Logical redundancy check)

# 3. CONNECTION

**⚠ WARNING**

For avoiding electric shock and malfunctions, do not turn on the power supply until all wiring have been completed.

## 3.1 Communication Terminal Allocation

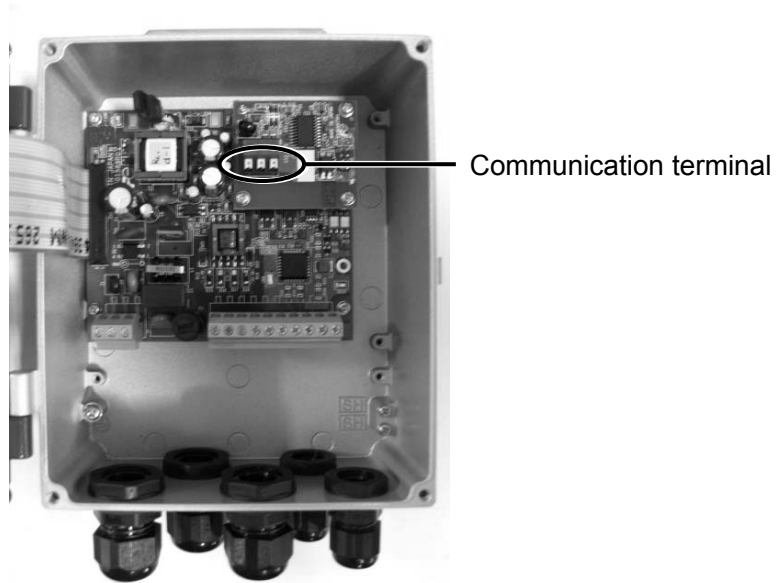

Communication Terminal

1	2	3
SG	A-	B+
RS-485		

■ Useable wire material

- Electric wire  
Thickness: AWG20 (0.5mm<sup>2</sup>) to AWG16 (1.5mm<sup>2</sup>)  
Strip-off length: 8 to 10mm

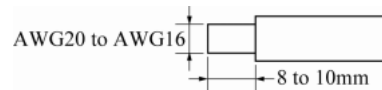

- Bar terminal  
Weidmüller  
[www.weidmüller.com](http://www.weidmüller.com)

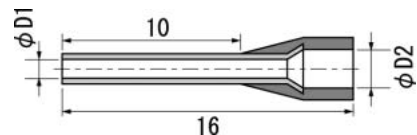

Electric wire thickness (mm <sup>2</sup> )	φ D1 (mm)	φ D2 (mm)	Model
0.5	1	2.6	H0.5/16
0.75	1.2	2.8	H0.75/16
1	1.4	3	H1/16
1.5	1.7	3.5	H1.5/16



## 3.2 Wiring

### 3.2.1 RS-485 interface

- Use twisted pair cables with shield.
  - Recommended cable: UL2464, UL2448, etc.
- The total extension length of the cable is up to 1000 m. A master station and up to 31 units of this instrument can be connected per line.
- Terminate the both ends of the cable with  $120\Omega$  ( $1/2$  W or higher) terminating resistors.
  - Note: See the specifications of the master for the terminating resistors of the master station unit.
- The shield wire of the cable should be grounded at one place on the master station unit side.
- If this instrument is to be installed where the level of noise applied to this instrument may exceed 1000 V, it is recommended to install a noise filter in the master station side as below.

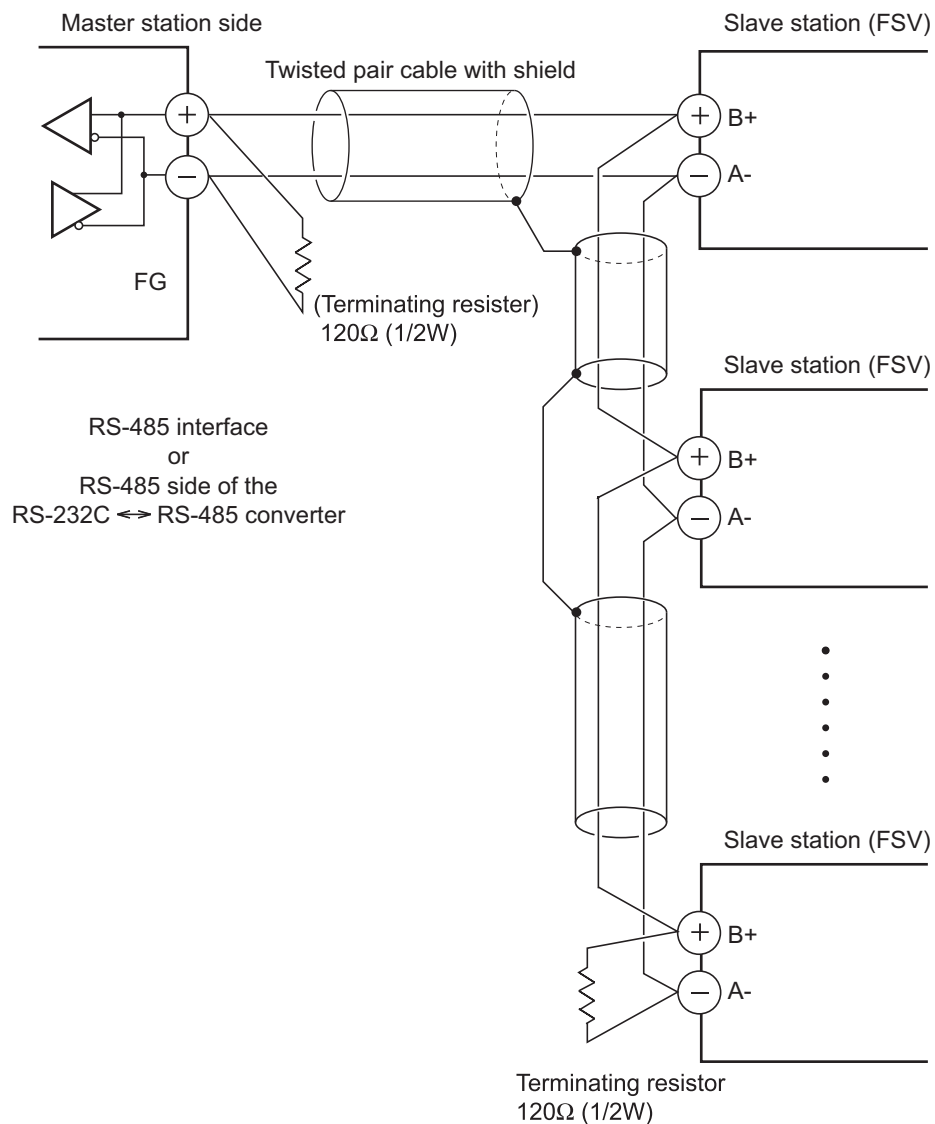
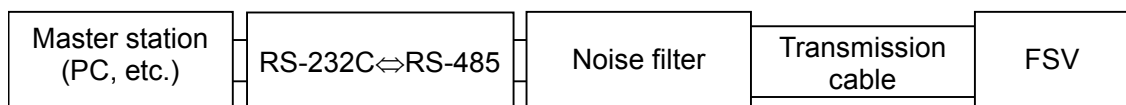

# 4. SETTING OF COMMUNICATION CONDITION

In order that the master station and instrument (this instrument) can correctly communicate, following settings are required.

- All communication condition settings of the master station are the same as those of instruments (this instrument).
- All instruments (this instrument) connected on a line are set to “Station No.” which are different from each other. Any “Station No.” is not shared by more than one instrument (when using the RS-485 interface).

## 4.1 Set Items

The parameters to be set are shown in the following table. Set them by operating the front panel keys.

Item	Value at delivery	Setting range	Remarks
Station No.	1	1 to 31 (0:communication function stop)	Set a different value to each station.
Transmission speed	9600 bps	9600 bps, 19200 bps, 38400 bps	Set the same communication condition to the master station and all slave stations.
Parity setting	Odd	None: None parity Odd: Odd parity Even: Even parity	
Data length	8 bits	Fixed (can not be changed)	
Stop bit	1 bit	1 bit, 2 bits	

## 4.2 Setting operation method

- (1) Make communication settings on the maintenance mode screen of the display setting area of the main unit. Refer to the separate instruction manual for “Fixed Type Ultrasonic Flowmeter,” INF-TN2F5VG-E, for the operation method.

# 5. MODBUS COMMUNICATION PROTOCOL

## 5.1 General

The communication system by the MODBUS protocol is that the communication is always started from the master station and a slave station responds to the received message.

Transmission procedures is as shown below.

- 1) The master station sends a command message to a slave station.
- 2) The slave station checks that the station No. in the received message matches with the own station No. or not.
- 3) If matched, the slave station executes the command and sends back the response message.
- 4) If mismatched, the slave station leaves the command message and wait for the next command message.

- a) In case when the station No. in the received command message matches with the own slave station No.

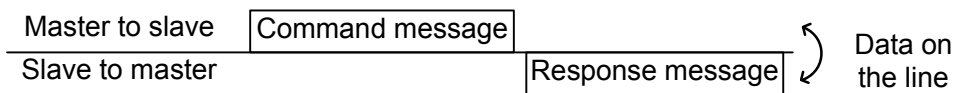

- b) In case when the station No. in the received command message mismatches with the own slave station No.

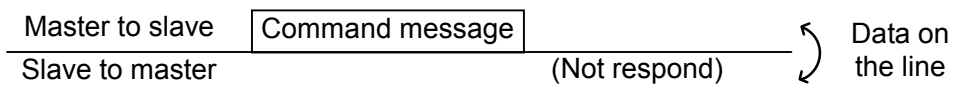

- 5) To assure safety, provide a structure where the response message is checked and retry is made three (3) times or more if no response is made or an error occurs.

The master station can individually communicate with any one of slave stations connected on the same line upon setting the station No. in the command message.

## 5.2 Composition of Message

Compositions of the command message and response message are as shown in Fig. 5-1. ; And these are sent in this order.

Station No. (1 byte)
Function code (1 byte)
Data (2 to 133 bytes)
Error check code (CRC-16) (2 bytes)

Fig. 5-1 Composition of message

In the following, each field is explained.

### (1) Station No.

Station No. is the number specifying a slave station. When RS-485 interface is used, the command message is received and operated only by the slave station (FSV) whose station No. matches with the No. set in “Station No.”

For details of setting the parameter “Station No.,” refer to Chapter 4.

### (2) Function code

This is a code to designate the function executed at a slave station.

For details, refer to Section 5.4.

### (3) Data

Data are the data required for executing function codes. The composition of data varies with function codes. For details, refer to Chapter 6.

A register number is assigned to each data in the flowmeter. For reading/writing the data by communication, designate the register number.

Note that the register number transmitted on message is expressed as its relative address.

The relative address is calculated by the following expression.

$$\boxed{\text{Relative address}} = \left( \text{The lower 4 digits of the } \boxed{\text{register number}} \right) - 1$$

For example, when the register number designated by a function code is 40003,

$$\begin{aligned} \text{Relative address} &= (\text{lower 4 digits of } 40003) - 1 \\ &= 0002 \end{aligned}$$

is used on the message.

### (4) Error check code

This is the code to detect message errors (change in bit) in the signal transmission.

On the MODBUS protocol (RTU mode), CRC-16 (Cyclic Redundancy Check) is applied.

For CRC calculation method, refer to Section 5.5.

## 5.3 Response of Slave Station

### (1) Response for normal command

To a relevant message, the slave station creates and sends back a response message which corresponds to the command message. The composition of message in this case is the same as in Section 5.2.

Contents of the data field depend on the function code. For details, refer to Chapter 6.

### (2) Response for abnormal command

If contents of a command message have an abnormality (for example, non-actual function code is designated) other than transmission error, the slave station does not execute that command but creates and sends back a response message at error detection.

The composition of response message at error detection is as shown in Fig. 5-2. The value used for function code field is function code of command message plus 80<sub>H</sub>.

Table 5-1 gives error codes.

Station No.
Function code + 80 <sub>H</sub>
Error code
Error check (CRC-16)

Fig. 5-2 Response message at error detection

Table 5-1 Error Code

Error code	Contents	Description
01H	Illegal function code	Non-actual function code is designated. Check for the function code.
02H	Illegal data address	A relative address of a register number to which the designated function code can not be used.
03H	Illegal data number	Because the designation of number is too much, the area where register numbers do not exist is designated.

### (3) No response

Under any of the following items, the slave station takes no action of the command message and sends back no response.

- A station number transmitted in the command message differs from the station number specified to the slave station.
- A error check code is not matched, or a transmission error (parity error, etc.) is detected.
- The time interval between the composition data of the message becomes longer than the time corresponding to 24 bits. (Refer to Section 5.6 Transmission Control Procedure)
- Station No. of a slave station is set to 0.
- Setting is made on the main unit with the operation keys.
- The main unit displays a write-in command on a screen other than the measurement screen.

## 5.4 Function Code

According to MODBUS protocol, register numbers are assigned by function codes.

Each function code acts on specific register number.

This correspondence is shown in Table 5-2, and the message length by function is shown in Table 5-3.

Table 5-2 Correspondence between function codes and objective address

Function code			Resister No.		
No.	Function	Object	No.	Contents	
03 <sub>H</sub>	Read-out (continuously)	Holding register	4xxxx	Read-out/write-in	word data
04 <sub>H</sub>	Read-out (continuously)	Input register	3xxxx	Read-out	word data
06 <sub>H</sub>	Write-in	Holding register	4xxxx	Read-out/write-in	word data
10 <sub>H</sub>	Write-in (continuously)	Holding register	4xxxx	Read-out/write-in	word data

Table 5-3 Function code and message length

[Unit:byte]

Function code	Contents	Number of designatable data	Command message		Response message	
			Minimum	Maximum	Minimum	Maximum
03 <sub>H</sub>	Read-out of word data	64 words	8	8	7	133
04 <sub>H</sub>	Read-out of word data (read-out only)	64 words	8	8	7	133
06 <sub>H</sub>	Write-in of word data	1 word	8	8	7	7
10 <sub>H</sub>	Write-in of continuous word data	64 words	11	137	8	8

## 5.5 Calculation of Error Check Code (CRC-16)

CRC-16 is the 2-byte (16-bits) error check code. From the top of the message (station No.) to the end of the data field are calculated.

The slave station calculates the CRC of the received message, and does not respond if the calculated CRC is different from the contents of the received CRC code.

Fig. 5-3 shows the flow of the CRC-16 calculation system.

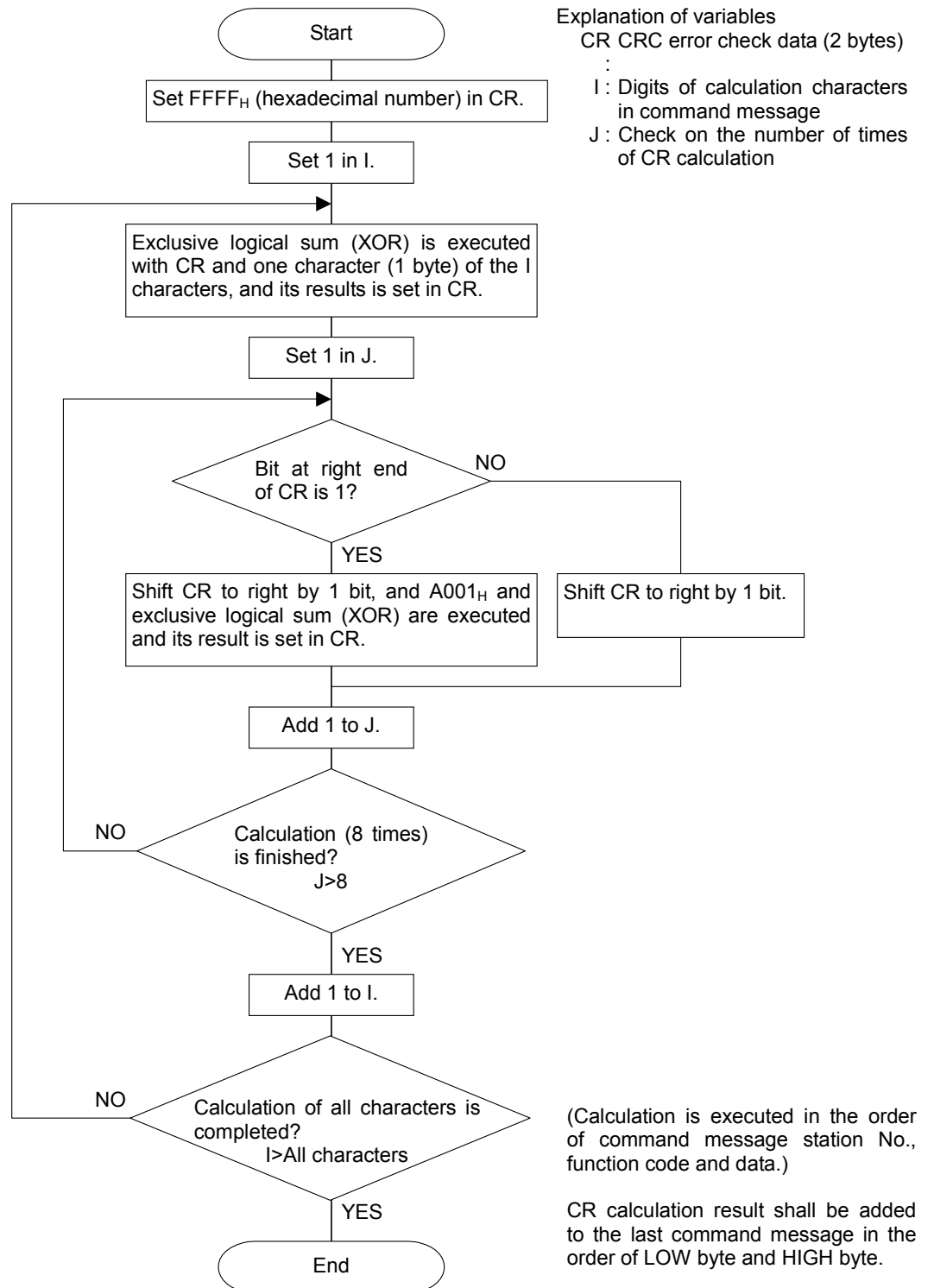

Fig. 5-3 Flow of CRC-16 calculation

## 5.6 Transmission Control Procedure

### (1) Transmission procedure of master station

The master station must proceed to a communication upon conforming to the following items.

- (1-1) Before sending a command message, provide 48 bits time or more vacant status.
- (1-2) For sending, the interval between bytes of a command message is below 24 bits time.
- (1-3) Within 24 bits time after sending a command message, the receiving status is posted.
- (1-4) Provide 48 bits time or more vacant status between the end of response message reception and beginning of next command message sending [same as in (1-1)].
- (1-5) For ensuring the safety, make a confirmation of the response message and make an arrangement so as to provide 3 or more retries in case of no response, error occurrence, etc.

Note) The above definition is for most unfavorable value. For ensuring the safety, it's recommended the program of the master to work with safety factors of 2 to 3. Concretely, it is advised to arrange the program for 9600 bps with 10 ms or more for vacant status (1-1), and within 1 ms for byte interval (1-2) and changeover from sending to receiving (1-3).

### (2) Description

#### 1) Detection of the message frame

This communication system may be 2 statuses on a line below.

- (a) Vacant status (no data on line)
- (b) Communication status (data is existing)

Instruments connected on the line are initially at a receiving status and monitoring the line. When 24 bits time or more vacant status has appeared on the line, the end of preceding frame is assumed and, within following 24 bits time, a receiving status is posted. When data appears on the line, instruments receive it while 24 bits time or more vacant status is detected again, and the end of that frame is assumed. I.e., data which appeared on the line from the first 24 bits time or more vacant status to the next 24 bits time or more vacant status is fetched as one frame.

Therefore, one frame (command message) must be sent upon confirming the following.

- (1-1) 48 bits time or more vacant status precedes the command message sending.
- (1-2) Interval between bytes of 1 command message is smaller than 24 bits time.

#### 2) Response of this instrument (FSV)

After a frame detection (24 bits time or more vacant status), this instrument carries out processing with that frame as a command message. If the command message is destined to the own station, a response message is returned. Its processing time is 5 to 60 ms (depends on contents of command message).

After sending a command message, therefore, the master station must observe the following

- (1-3) Receiving status is posted within 24 bits time after sending a command message.



Space time of longer than 25 ms is needed.

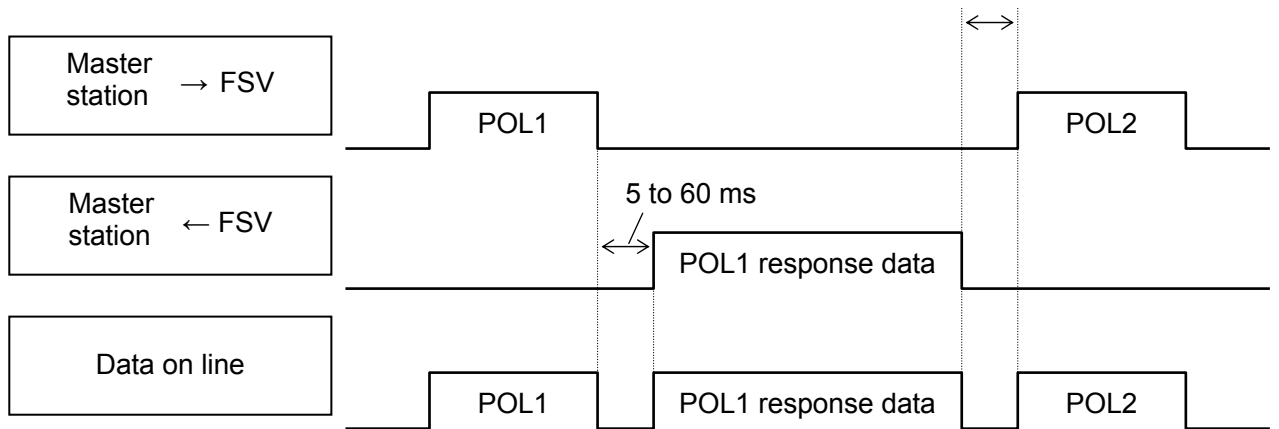

## 5.7 FIX Processing (Cautions in data write)

The instrument is provided inside with a non-volatile memory (FRAM) for holding the setting parameters.

Data written in the non-volatile memory is not lost even if turning off the power.

To hold parameters that were written in the internal memory via communication after turning off the power, the FIX process is effective. It allows parameters to be written in nonvolatile memory.

Fig.5-4 shows the FIX procedure.

### Cautions:

- Write in the non-volatile memory takes approximately 2 seconds.
- While writing, do not turn off the power of the FSV. Otherwise, the data in the non-volatile memory will be destroyed, whereby the FSV could not be used any longer.
- Don't change parameters on the front panel when performing the FIX procedure, or memory error may result.
- Therefore, limit the times of change of parameter setting to absolute minimum. Refrain from carrying out the FIX processing periodically for example or while such is not absolutely required.

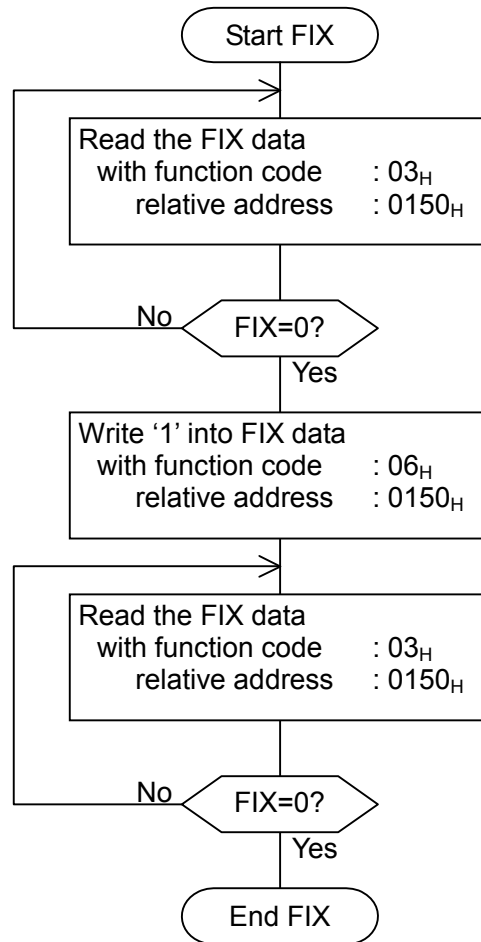

Fig.5-4 FIX procedure

# 6. DETAILS OF MESSAGE

## 6.1 Read-out of Word Data [Function code:03<sub>H</sub>]

Function code	Max. word number read-out in one message	Relative data address	Register No.	Kind of data
03 <sub>H</sub>	64 words	0000 <sub>H</sub> —014F <sub>H</sub>	40001—40336	Storage enable data
		0150 <sub>H</sub> —0171 <sub>H</sub>	40337—40370	Storage disable data

### (1) Message composition

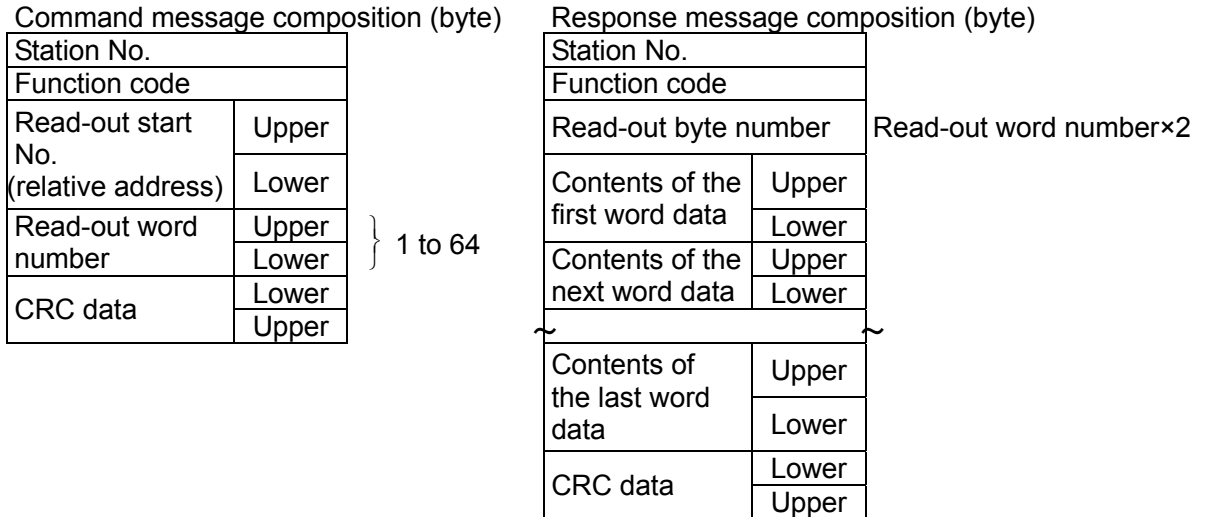

\* Arrangement of read-out word data

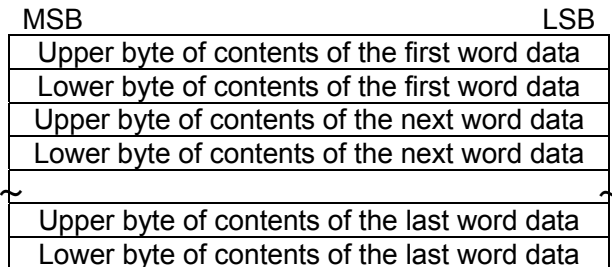

### (2) Function explanations

Word data of continuous word numbers from the read-out start No. can be read. Read-out word data are transmitted from the slave station in the order of upper and lower bytes.

### (3) Message transmission (example)

Reading "Damping" from No. 2 station is shown below.

Relative address of damping: 0000<sub>H</sub> (Register No.40001), Data number: 01<sub>H</sub>

Command message composition (byte)

Station No.	02 <sub>H</sub>	
Function code	03 <sub>H</sub>	
Read-out start No. (relative address)	Upper	00 <sub>H</sub>
	Lower	00 <sub>H</sub>
Read-out word number	Upper	00 <sub>H</sub>
	Lower	01 <sub>H</sub>
CRC data	Lower	84 <sub>H</sub>
	Upper	39 <sub>H</sub>

Response message composition (byte)

Station No.	02 <sub>H</sub>	
Function code	03 <sub>H</sub>	
Read-out byte number	02 <sub>H</sub>	
Contents of the first word data	Upper	00 <sub>H</sub>
	Lower	64 <sub>H</sub>
CRC data	Lower	FD <sub>H</sub>
	Upper	AF <sub>H</sub>

\* Meaning of data to be read

Damping 00 64<sub>H</sub> = 100  
(contents of the first word data)

Where the unit is sec with decimal point position set at 1,

Damping = 10.0 sec

 For "Point" decimal point, refer to Section 7.1.

## 6.2 Read-out of Read-out Only Word Data [Function code:04<sub>H</sub>]

Function code	Max. word number read-out in one message	Relative data address	Register No.
04 <sub>H</sub>	64 words	0000 <sub>H</sub> —00DF <sub>H</sub>	30001—30192

### (1) Message composition

Command message composition (byte)		Response message composition (byte)	
Station No.		Station No.	
Function code		Function code	
Read-out start No. (relative address)	Upper	Read-out byte number Read-out word number×2	
	Lower		
Read-out word number	Upper	Contents of the first word data	Upper
	Lower		Lower
CRC data	Lower	Contents of the next word data	Upper
	Upper		Lower
		Contents of the last word data	
		Upper	
		Lower	
		CRC data	
		Lower	
		Upper	

\* Arrangement of read-out word data

MSB	LSB
Upper byte of contents of the first word data	
Lower byte of contents of the first word data	
Upper byte of contents of the next word data	
Lower byte of contents of the next word data	
Contents of the last word data	
Upper byte of contents of the last word data	
Lower byte of contents of the last word data	

### (2) Function explanations

Word data of continuous word numbers from the read-out start No. can be read. Read-out word data are transmitted from the slave station in the order of upper and lower bytes.

### (3) Message transmission (example)

The following is an example of reading out the flow rate from station No. 1.

Relative address of the flow rate: 0004<sub>H</sub> (Register No. 30005), Number of data to be read out: 02<sub>H</sub>

Command message composition (byte)

Station No.		01 <sub>H</sub>
Function code		04 <sub>H</sub>
Read-out start No. (relative address)	Upper	00 <sub>H</sub>
	Lower	04 <sub>H</sub>
Read-out word number	Upper	00 <sub>H</sub>
	Lower	02 <sub>H</sub>
CRC data	Lower	30 <sub>H</sub>
	Upper	0A <sub>H</sub>

Response message composition (byte)

Station No.		01 <sub>H</sub>
Function code		04 <sub>H</sub>
Read-out byte number		04 <sub>H</sub>
Contents of the first word data	Upper	43 <sub>H</sub>
	Lower	40 <sub>H</sub>
Contents of the next word data	Upper	00 <sub>H</sub>
	Lower	00 <sub>H</sub>
CRC data	Lower	EF <sub>H</sub>
	Upper	D4 <sub>H</sub>

#### Meaning of read-out data

Data having the unit m<sup>3</sup>/h and floating decimal point

The read-out data is expressed as a 32-bit single-precision floating value.

Connect the read-out 4-byte data, and convert it into an actual value using an appropriate conversion program.

Flow rate, 192.0 m<sup>3</sup>/h = 1.5x (2 to the 7th power)

$$= 0100\ 0011\ 0100\ 0000\ 0000\ 0000\ 0000\ 0000 \text{ (binary number)}$$

Refer to Section 7.1 for handling of floating data.

➤ **Point** ➤ For handling of floating data, refer to Section 7.1.

## 6.3 Write-in of Word Data [Function code:06<sub>H</sub>]

Function code	Max. word number write-in in one message	Relative data address	Register No.	Kind of data
06 <sub>H</sub>	1 word	0140 <sub>H</sub> —014F <sub>H</sub>	40321—40336	Storage enable data
		0150 <sub>H</sub> —0171 <sub>H</sub>	40337—40370	Storage disable data

### (1) Message composition

Command message composition (byte)

Station No.	
Function code	
Write-in designate No. (relative address)	Upper
	Lower
Write-in word data	Upper
	Lower
CRC data	Lower
	Upper

Response message composition (byte)

Station No.	
Function code	
Write-in designate No. (relative address)	Upper
	Lower
Write-in word data	Upper
	Lower
CRC data	Lower
	Upper

### (2) Function explanation

Designated word data is written in write-in designate No. Write-in data are transmitted from master station in the order of upper and lower bytes.

The current value is returned when the write-in data does not fall within the effective range.

### (3) Message transmission (example)

The following shows an example of transmitting the “Zero adjustment” key command to No.1 station.

Key operation command Relative address: 0140<sub>H</sub>

Command message composition (byte)

Station No.		01 <sub>H</sub>
Function code		06 <sub>H</sub>
Write-in designate No. (relative address)	Upper	01 <sub>H</sub>
	Lower	40 <sub>H</sub>
Write-in word data	Upper	00 <sub>H</sub>
	Lower	01 <sub>H</sub>
CRC data	Lower	48 <sub>H</sub>
	Upper	22 <sub>H</sub>

} “Brightness UP” key command

Response message composition (byte)

Station No.		01 <sub>H</sub>
Function code		06 <sub>H</sub>
Write-in designate No. (relative address)	Upper	01 <sub>H</sub>
	Lower	40 <sub>H</sub>
Write-in word data	Upper	00 <sub>H</sub>
	Lower	01 <sub>H</sub>
CRC data	Lower	48 <sub>H</sub>
	Upper	22 <sub>H</sub>

## 6.4 Write-in of continuous word data [Function code:10<sub>H</sub>]

Function code	Max. word number write-in in one message	Relative data address	Register No.	Kind of data
10 <sub>H</sub>	64 word	0000 <sub>H</sub> —013F <sub>H</sub>	40001—40320	Storage enable data

### (1) Message composition

Command message composition (byte)

Station No.	
Function code	
Write-in start No. (relative address)	Upper
	Lower
Write-in word number	Upper
	Lower
Write-in byte number	
First write-in word data	Upper
	Lower
Next write-in word data	Upper
	Lower
Last write-in word data	
	Upper
	Lower
CRC data	Lower
	Upper

} 1 to 64

} Write-in word number × 2

Response message composition (byte)

Station No.	
Function code	
Write-in start No. (relative address)	Upper
	Lower
Write-in word number	Upper
	Lower
CRC data	Lower
	Upper

\* Arrangement of write-in word data

MSB

LSB

Upper byte of contents of the first word data
Lower byte of contents of the first word data
Upper byte of contents of the next word data
Lower byte of contents of the next word data
Upper byte of contents of the last word data
Lower byte of contents of the last word data

### (2) Function explanation

Word data of continuous word number is written from write-in start address. Write-in word data are transmitted from master station in the order of upper and lower bytes.

If write-in data does not fall within the effective range, response is made without counting it as write-in word number. If an attempt is made to write data in an unused address, write-in is not performed, and response is made without counting it as write-in word number.



### (3) Message transmission (example)

Writing Flow unit = m<sup>3</sup>/h, Range type = single range, Full scale 1 = 300.0 m<sup>3</sup>/h in No. 1 station is shown below.

Flow unit = 0006<sub>H</sub> (= 6<sub>D</sub>)

Range type = 0000<sub>H</sub> (= 0<sub>D</sub>)

Full scale 1 = 4072 C000 0000 0000 (= 300.0<sub>D</sub>) (64-bit double precision float type)

Relative address of Flow unit: 0004<sub>H</sub> (Register No. 40005), Data number: 06<sub>H</sub>

Command message composition (byte)

Station No.		01 <sub>H</sub>
Function code		10 <sub>H</sub>
Write-in start No. (relative address)	Upper	00 <sub>H</sub>
	Lower	04 <sub>H</sub>
Write-in word number	Upper	00 <sub>H</sub>
	Lower	06 <sub>H</sub>
Write-in byte number		0C <sub>H</sub>
First write-in word data	Upper	00 <sub>H</sub>
	Lower	06 <sub>H</sub>
Next write-in word data	Upper	00 <sub>H</sub>
	Lower	00 <sub>H</sub>
Next write-in word data	Upper	40 <sub>H</sub>
	Lower	72 <sub>H</sub>
Next write-in word data	Upper	C0 <sub>H</sub>
	Lower	00 <sub>H</sub>
Next write-in word data	Upper	00 <sub>H</sub>
	Lower	00 <sub>H</sub>
Last write-in word data	Upper	00 <sub>H</sub>
	Lower	00 <sub>H</sub>
CRC data	Lower	51 <sub>H</sub>
	Upper	AB <sub>H</sub>

Response message composition (byte)

Station No.		01 <sub>H</sub>
Function code		10 <sub>H</sub>
Write-in start No. (relative address)	Upper	00 <sub>H</sub>
	Lower	04 <sub>H</sub>
Write-in word number	Upper	00 <sub>H</sub>
	Lower	06 <sub>H</sub>
CRC data	Lower	01 <sub>H</sub>
	Upper	CA <sub>H</sub>



For handling of floating data, refer to Section 7.1.

For transmission format of each data, refer to the address map (Chapter 7.)

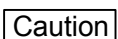

If the write-in command message is sent to any slave station during the FIX process, response is not returned from it.

# 7. ADDRESS MAP AND DATA FORMAT

## 7.1 Data Format

### 7.1.1 Transmission data format

The MODBUS protocol used in this product is RTU (Remote Terminal Unit) mode.  
The transmitted data is “numerical value”, but ASCII code data is partly included.

### 7.1.2 Handling of decimal point

Numerical value data includes integer data, decimal point position fixed data and floating data. Handling of data containing a decimal point is described below.

(1) Data with determined decimal point position (int type, long type)

No decimal point is added in the transmission data. Execute decimal point position alignment processing (elimination of decimal point at the time of transmission, addition of decimal point at the time of reception) on data with decimal point.

Example: Case of damping data  
 Read-out data: 03 E8<sub>H</sub> = 1000  
 Decimal point position: 1 digit  
 Value: 100.0sec

(2) 32-bit floating data (float type)

Instantaneous values or the like are expressed by 32-bit single precision float type.  
The meaning of each bit is as follows (standard format specified in IEEE).

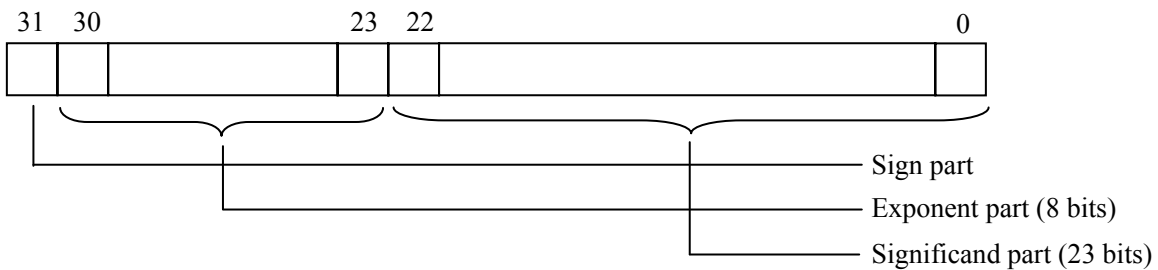

1) Sign part

Indicates the sign of the floating decimal point. “0” represents “positive”, and “1” represents “negative”.

2) Exponent part

Indicates the exponent of the floating decimal point by a power of 2. The value obtained by subtracting 127 from this value is the actual exponent.

3) Significand part

This is the data that corresponds to the significant figure of the floating decimal point. The actual numerical value is interpreted by adding 1 to the top.

Example: 1 10000000 11000000000000000000000  
 Sign : Minus  
 Exponent :  $10000000_{(2)} - 127 = 1$   
 Significand :  $1.11_{(2)} = 1 + 1/2 + 1/4 = 1.75$   
 Value :  $-1.75 \times (1\text{st power of } 2) = -3.5$

(3) 64-bit floating data (double type)

Instantaneous values or the like are expressed by 64-bit double precision float type.

The meaning of each bit is as follows (standard format specified in IEEE).

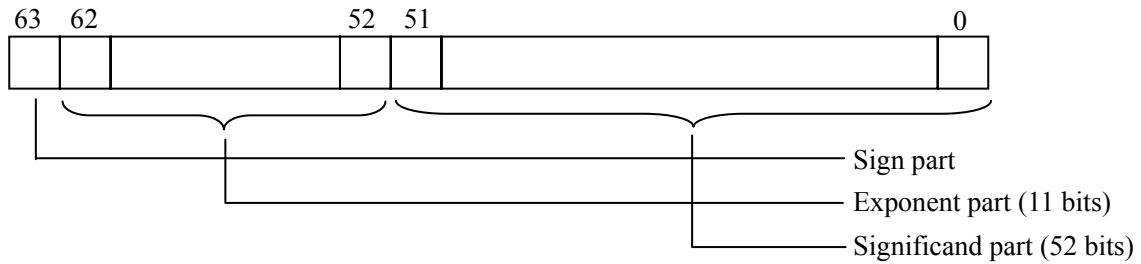

1) Sign part

Indicates the sign of the floating decimal point. “0” represents “positive”, and “1” represents “negative”.

2) Exponent part

Indicates the exponent of the floating decimal point by a power of 2. The value obtained by subtracting 1023 from this value is the actual exponent.

3) Significand part

This is the data that corresponds to the significant figure of the floating decimal point. The actual numerical value is interpreted by adding 1 to the top.

Example: 0 0111111111 1110000000000000000000000000000000000000000000000000000000000

Sign : Plus  
Exponent :  $0111111111_{(2)} - 1023 = 0$   
Significand :  $1.111_{(2)} = 1 + 1/2 + 1/4 + 1/8 = 1.875$   
Value :  $1.875 \times (0\text{th power of } 2) = 1.875$

### 7.1.3 Handling of measured data on occurrence of range over

Even if the measured data (instantaneous value) is in excess of the scale range, the measured data (velocity or flow rate) is transmitted as it is as the instantaneous value Read-out data.

## 7.2 Address Map

See the instruction manual attached to the main unit for details of functions and setting ranges of individual parameters.

Data type unsigned char: Byte data without sign. This data is handled in byte units. One data per address  
 int : Word data with sign. This data is handled in word units. One data per two addresses  
 unsigned int : Word data without sign. This data is handled in word units. One data per two addresses  
 Long : 2-word data with sign. This data is handled in 2-word units. One data per four addresses  
 float : Floating data. This data is handled in 2-word units. One data per four addresses  
 double : Floating data. This data is handled in 4-word units. One data per eight addresses

### 7.2.1 Word data [Read-out/Write-in]: Function code [ 03H, 10H ]

Relative address	Register No.	Data type	Parameter	Read-out data/Write-in data setting range	Remarks
	4XXXX				
0000	40001	int	Damping	1 place after the decimal point, 0.0 to 100.0sec	
0002	40003	int	Range kind	0: Velocity, 1: Flow rate	
0004	40005	int	Flow rate unit	Metric system : 0:L/s, 1:L/min, 2:L/h, 3:L/d, 4:kL/d, 5:ML/d, 6:m <sup>3</sup> /s, 7:m <sup>3</sup> /min, 8:m <sup>3</sup> /h, 9:m <sup>3</sup> /d, 10:km <sup>3</sup> /d, 11:Mm <sup>3</sup> /d, 12:BBL/s, 13:BBL/min, 14:BBL/h, 15:BBL/d, 16:kBBL/d, 17:MBBL/d English system : 0:gal/s, 1:gal/min, 2:gal/h, 3:gal/d, 4:kgal/d, 5:Mgal/d, 6:ft <sup>3</sup> /s, 7:ft <sup>3</sup> /min, 8:ft <sup>3</sup> /h, 9:ft <sup>3</sup> /d, 10:kft <sup>3</sup> /d, 11:Mft <sup>3</sup> /d, 12:BBL/s, 13:BBL/min, 14:BBL/h, 15:BBL/d, 16:kBBL/d, 17:MBBL/d	
0006	40007	int	Range type	0: Single range, 1: Auto 2 range, 2: Forward-reverse range, 3: Forward-reverse auto 2 range	
0008	40009	double	Full scale 1	Metric system: 64-bit floating data; 0, ±0.3 to ±32m/s as converted to flow rate English system: 64-bit floating data	Unit: Flow rate
0010	40017	double	Full scale 2	Metric system: 64-bit floating data; 0, ±0.3 to ±32m/s as converted to flow rate English system: 64-bit floating data	Unit: Flow rate
0018	40025	int	Range hysteresis	2 places after the decimal point, 0.00 to 20.00%	
001A	40027	int	Burnout	0: Not use, 1: Hold, 2: Upper, 3: Lower, 4: Zero	
001C	40029	int	Burnout timer	Decimal point fixed, 0 to 900sec	
001E	40031	int	Output limit low	Decimal point fixed, -20 to 0%	
0020	40033	int	Output limit high	Decimal point fixed, 100 to 120%	
0022	40035	int	Rate limit timer	Decimal point fixed, 0 to 900sec	
0024	40037	double	Rate limit	Metric system: 64-bit floating data; 0 to 5m/s as converted to flow rate English system: 64-bit floating data	Unit: Flow rate
002C	40045	double	Low flow rate cut	Metric system: 64-bit floating data; 0 to 5m/s as converted to flow rate English system: 64-bit floating data	Unit: Flow rate
0034	40053	double	Calibration zero	Metric system: 64-bit floating data; ±5m/s as converted to flow rate English system: 64-bit floating data	Unit: Flow rate
003C	40061	int	Calibration span	2 places after the decimal point, 0.00 to 200.00%	
003E	40063	int	Operation mode	0: Normal, 1: High speed response mode	
0040	40065	int	Total unit *1	Metric system : 0:mL, 1:L, 2:m <sup>3</sup> , 3:km <sup>3</sup> , 4:Mm <sup>3</sup> , 5:mBBL, 6:BBL, 7:kBBL English system : 0:gal, 1:kgal, 2:ft <sup>3</sup> , 3:kft <sup>3</sup> , 4:Mft <sup>3</sup> , 5:mBBL, 6:BBL, 7:kBBL, 8:ACRf	

Relative address	Register No.	Data type	Parameter	Read-out data/Write-in data setting range	Remarks
0042	40067	int	Total mode	0: Start, 1: Stop, 2: Total reset	
0044	40069	double	Total constant *1	64-bit floating data, 0 to 99999999	Unit: Total
004C	40077	double	Total preset *1	64-bit floating data, 0 to 99999999	Unit: Total
0054	40085	int	Pulse width *1	0: 5.0 msec, 1: 10.0 msec, 2: 50.0 msec, 3: 100.0 msec, 4: 200.0 msec, 5: 500.0 msec, 6: 1000.0 msec	
0056	40087	int	Burnout	0: Hold, 1: Not use	
0058	40089	int	Burnout timer	Decimal point fixed, 0 to 900sec	
005A	40091	int	DO1 out	0: Not use, 1: + Total pulse, 2: – Total pulse, 3: Full scale 2, 4: Alarm, 5: Flow switch, 6: Total switch, 7: Ao range over, 8: Pulse range over, 9: – Flow direction	
005C	40093	int	Alarm	0: All, 1: Equipment error, 2: Process error	
005E	40095	int	Flow rate switch	0: Upper flow rate, 1: Lower flow rate	
0060	40097	double	Upper flow rate	Metric system: 64-bit floating data; 0 to 32m/s as converted to flow rate English system: 64-bit floating data	Unit: Flow rate
0068	40105	double	Lower flow rate	Metric system: 64-bit floating data; 0 to 32m/s as converted to flow rate English system: 64-bit floating data	Unit: Flow rate
0070	40113	double	Total switch *1	64-bit floating data, 0 to 99999999	Unit: Total
0078	40121	int	DO1 contact action	0: Active ON, 1: Active OFF	
007A	40123	int	DO2 out	0: Not use, 1: + Total pulse, 2: – Total pulse, 3: Full scale 2, 4: Alarm, 5: Flow switch, 6: Total switch, 7: Ao range over, 8: Pulse range over, 9: – Flow direction	
007C	40125	int	Alarm	0: All, 1: Equipment error, 2: Process error	
007E	40127	int	Flow rate switch	0: Upper flow rate, 1: Lower flow rate	
0080	40129	double	Upper flow rate	Metric system: 64-bit floating data; 0 to 32m/s as converted to flow rate English system: 64-bit floating data	Unit: Flow rate
0088	40137	double	Lower flow rate	Metric system: 64-bit floating data; 0 to 32m/s as converted to flow rate English system: 64-bit floating data	Unit: Flow rate
0090	40145	double	Total switch *1	64-bit floating data, 0 to 99999999	Unit: Total
0098	40153	int	DO2 contact action	0: Active ON, 1: Active OFF	
009A	40155	int			Not use
009C	40157	int			Not use
009E	40159	int			Not use
00A0	40161	double			Not use
00A8	40169	double			Not use
00B0	40177	double			Not use
00B8	40185	int			Not use
00BA	40187	int			Not use
00BC	40189	int			Not use
00BE	40191	int			Not use
00C0	40193	int	1st row	0: Velocity, 1: Flow rate, 2: Flow rate (%), 3: + Total (actual), 4: + Total pulse, 5: – Total (actual), 6: – Total pulse	
00C2	40195	int	Decimal point position of 1st row	0: * .***** , 1: ** .***** , 2: *** .**** , 3: **** .*** , 4: ***** .** , 5: ***** .* , 6: *****.	Write-in is not permitted in case the row is “Velocity”, “+ Total pulse” or “– Total pulse”.
00C4	40197	Int	2nd row	0: Velocity, 1: Flow rate, 2: Flow rate (%), 3: + Total (actual), 4: + Total pulse, 5: – Total (actual), 6: – Total pulse	

Relative address	Register No.	Data type	Parameter	Read-out data/Write-in data setting range	Remarks
00C6	40199	int	Decimal point position of 2nd row	0: * .*****, 1: ** .*****, 2: *** .*****, 3: **** .***, 4: ***** .**, 5: ***** .*, 6: *****.	Write-in is not permitted in case the row is "Velocity", "+ Total pulse" or "- Total pulse".
00C8	40201	int	LCD Backlight	0: ON, 1: OFF	
00CA	40203	int	LCD Backlight out time	0 to 99 min	
00CC	40205				
00CE	40207				
00D0	40209	int	Sensor type	2: FSSA/FSSG, 3: FLS_12/FLS_22, 4: FSSC, 5: FSG_32, 6: FSG_31/FSG_41, 7: FSSE/FSG_50, 8: FSSF/FSG_51, 9: FSD12, 10: FSSD/FSD22, 11: FSSH/FSD32	
00D2	40211	long	Outside diameter	Metric system: 2 places after decimal point, 6.00 to 6200.00mm English system: 4 places after decimal point, 0.2362 to 244.100inch	
00D6	40215	int	Pipe material	0: Carbon steel, 1: Stainless steel, 2: PVC, 3: Copper, 4: Cast iron, 5: Aluminum, 6: FRP, 7: Ductile iron, 8: PEEK, 9: PVDF, 10: Acrylic, 11: PP, 12: Pipe S.V.	
00D8	40217	int	Pipe S.V.	Metric system: Decimal point fixed, 1000 to 3700m/s English system: Decimal point fixed, 3280 to 12140ft/s	Write-in is permitted in case pipe material is "12: Pipe S.V."
00DA	40219	long	Pipe wall thickness	Metric system: 2 places after decimal point, 0.10 to 100.00mm English system: 4 places after decimal point, 0.0039 to 3.9380inch	
00DE	40223	int	Lining material	0: No lining, 1: Tar epoxy, 2: Mortar, 3: Rubber, 4: Teflon, 5: Pyrex glass, 6: PVC, 7: Lining S.V.	
00E0	40225	int	Lining S.V.	Metric system: Decimal point fixed, 1000 to 3700m/s English system: Decimal point fixed, 3280 to 12140ft/s	Write-in is permitted in case lining material is "7: Lining S.V."
00E2	40227	long	Lining thickness	Metric system: 2 places after decimal point, 0.10 to 100.00mm English system: 4 places after decimal point, 0.0003 to 3.9380inch	
00E6	40231	int	Kind of fluid	0: Water, 1: Seawater, 2: Distilled water, 3: Ammonia, 4: Alcohol, 5: Benzene, 6: Bromide, 7: Ethanol, 8: Glycol, 9: Kerosene, 10: Milk, 11: Methanol, 12: Toluol, 13: Lube oil, 14: Fuel oil, 15: Petrol, 16: Refrigerant R410, 17: Fluid S.V.	
00E8	40233	int	Fluid S.V.	Metric system: Decimal point fixed, 300 to 2500m/s English system: Decimal point fixed, 984 to 8203ft/s	
00EA	40235	double	Viscosity	Metric system: 32-bit floating data; 0.001 to 999.999 E-6m <sup>2</sup> /s English system: 32-bit floating data; 0.0107 to 10764 E-6ft <sup>2</sup> /s	
00F2	40243	int	Sensor mount	0: V method, 1: Z method	
00F4	40245	int			Not use
00F6	40247	int			Not use
00F8	40249	int			Not use
00FA	40251	int			Not use
00FC	40253	int			Not use
00FE	40255	int			Not use
0100	40257	int	System unit *1	0: Metric, 1: English	
0102	40259	int	System language	0: English, 1: Japanese, 2: German, 3: French, 4: Spanish	
0104	40261	int	ID No. setup	Decimal point fixed, 0 to 9999	

Relative address	Register No.	Data type	Parameter	Read-out data/Write-in data setting range	Remarks
0106	40263	int	Transmission count	Normal operation mode: 3:8, 4:16, 5:32, 6:64, 7:128, 8:256 High speed operation mode: 0:4, 1:8, 2:16, 3:32, 4:64, 5:128	
0108	40265	int	Trigger control	0: Auto, 1: Manual	
010A	40267	int	Trigger level	Decimal point fixed, 10 to 90%	
010C	40269	int	Window control	0: Auto, 1: Manual	
010E	40271	int	U: Open time	Decimal point fixed, 1 to 16383	
0110	40273	int	D: Open time	Decimal point fixed, 1 to 16383	
0112	40275	int	Saturation	Decimal point fixed, 0 to 512	
0114	40277	int	Measure method	0: Method 1, 1: Method 2, 2: Method 3	
0116	40279	int	Wave receiving balance	Decimal point fixed, 0 to 100%	
0118	40281	int	Transmission pattern	0: Burst 1, 1: Burst 2, 2: Burst 3, 3: Burst 4, 4: Burst 5, 5: Chirp 4, 6: Chirp 8, 7: Reserve	
011A	40283	int	AGC gain	0: Auto, 1: Manual	
011C	40285	int	U:AGC	2 places after decimal point, 1.28 to 98.56	
011E	40287	int	D:AGC	2 places after decimal point, 1.28 to 98.56	
0120	40289	int	Wave receiving peak	0:0.125V(1024), 1:0.25V(2048), 2:0.375V(3072), 3:0.5V(4096)	
0122	40291	int	Transmission wait time	Decimal point fixed, 5 to 30msec	
0124	40293	int			Not use, write-in inhibited.
to	to				Not use, write-in inhibited.
013E	40319	int			Not use, write-in inhibited.

\*1) Total set value and system unit may be set only in the state where the total mode is stop. (If write-in is attempted without stopping, response occurs without counting in the write-in byte count.)

\*2) Read only in the setting screen. No response is made against write-in. Setting from communication is permitted only in the protected state.

## 7.2.2 Word data [Read-out/Write-in]: Function code [ 03H, 06H ]

Relative address	Register No.	Data type	Parameter	Read-out data/Write-in data setting range	Remarks
0140	40321	int	Zero adjustment	0: Clear, 1: Adjust	
0142	40323	unsigned int	4mA	No decimal point, 50 to 7148	
0144	40325	unsigned int	20mA	No decimal point, 7148 to 15950	
0146	40327	int			Not use, write-in inhibited.
0148	40329	int			Not use, write-in inhibited.
to	to				Not use, write-in inhibited.
014E	40335	int			Not use, write-in inhibited.

The address data indicated below is not stored in the main unit.

Relative address	Register No.	Data type	Parameter	Read-out data/Write-in data setting range	Remarks
0150	40337	int	Set value storage request	Read-out data: 0: Completed, 1: Being stored Write-in data : 1: Storage	
0152	40339	int	Memory initialize	Read-out data: 0 Write-in data : 100: Initialize	Communication is disabled for about 5 seconds after initialization.
0154	40341	int	Output setting (current check)	Decimal point fixed, -20 to 120%	
0156	40343	int	Total pulse check	Decimal point fixed, 1 to 100PULSE/s	
0158	40345	int	DO check	0: ON, 1: OFF	
015A	40347	int			Not use, write-in inhibited
015C	40349	int	Test mode	0: Not use, 1: Set	
015E	40351	int	Input data	Decimal point fixed, ±120%	
0160	40353	int	Tracking time	Decimal point fixed, 0 to 900sec	
0162	40355	int	LCD & LED check *3	0: Not use, 1: Check	
0164	40357	int	Key test *3	Read-out data: 10: No key pressing, 20: ESC key, 40: UP key, 80: ENT key, 100: SET key Write-in data : 0: Not use, 1: Start	
0166	40359	int	Test cancel	Read-out data: 0: Termination, 1: Being tested Write-in data : 0: Termination	Cancellation of testing of current, total pulse, DO check and test mode
0168 to 0170	40361 to 40369	int			Not use, write-in inhibited.

\*3) No response is made if execution is attempted in a screen other than measure screen.



### 7.2.3 Word data [Read-out only]: Function code [04H]

Relative address	Register No.	Data type	Parameter	Read-out data/Write-in data setting range	Remarks
	3XXXX				
0000	30001	float	Velocity	Metric system: 32-bit floating data, Unit: m/s English system: 32-bit floating data, Unit: ft/s	
0004	30005	float	Flow rate	32-bit floating data	Unit: Flow rate
0008	30009	float	Flow rate %	32-bit floating data, Unit: %	
000C	30013	double	+ Total value	64-bit floating data	Unit: Total
0014	30021	double	- Total value	64-bit floating data	
001C	30029	long	+ Total pulse	No decimal point, Unit: Pulse	
0020	30033	long	- Total pulse	No decimal point, Unit: Pulse	
0024	30037	unsigned int	RAS information	Data of hexadecimal number	
0026	30039	int			Not use
0028	30041	int			Not use
002A	30043	int			Not use
002C	30045	int			Not use
002E	30047	int			Not use
0030	30049	int	Wedge S.V.	Metric system: No decimal point, Unit: m/s English system: No decimal point, Unit: ft/s	
0032	30051	int	Wedge incidence angle	1 place after decimal point, Unit: °	
0034	30053	int	Pipe S.V.	Metric system: No decimal point, Unit: m/s English system: No decimal point, Unit: ft/s	
0036	30055	int	Pipe incidence angle	1 place after decimal point, Unit: °	
0038	30057	int	Lining S.V.	Metric system: No decimal point, Unit: m/s English system: No decimal point, Unit: ft/s	
003A	30059	int	Lining incidence angle	1 places after decimal point, Unit: °	
003C	30061	int	Fluid S.V.	Metric system: No decimal point, Unit: m/s English system: No decimal point, Unit: ft/s	
003E	30063	int	Water incidence angle	1 place after decimal point, Unit: °	
0040	30065	int	Propagation time (T0 C)	No decimal point, Unit: μs	
0042	30067	int	Window open (Win C)	No decimal point, Unit: μs	
0044	30069	long	Positive direction time (T1)	3 place after decimal point, Unit: μs	
0048	30073	long	Backward direction time (T2)	3 place after decimal point, Unit: μs	
004C	30077	long	Propagation time (T0)	3 place after decimal point, Unit: μs	
0050	30081	long	Propagation time difference (DT)	4 place after decimal point, Unit: ns	
0054	30085	long	Delay time (Ta)	3 place after decimal point, Unit: μs	
0058	30089	long	Water incidence angle (θf)	3 place after decimal point, Unit: °	
005C	30093	long	Fluid S.V. (Cf)	Metric system: 1 places after decimal point, Unit: m/s English system: 1 places after decimal point, Unit: ft/s	
0060	30097	long	Reynolds number (Re)	No decimal point	
0064	30101	long	Flow profile compensation factor (K)	4 places after decimal point	
0068	30105	long	Mean velocity (V)	Metric system: 3 places after decimal point, Unit: m/s English system: 3 places after decimal point, Unit: ft/s	
006C	30109	int	U: Signal strength (AGC U)	2 places after decimal point, 0.00 to 100.00%	
006E	30111	int	D: Signal strength (AGC D)	2 places after decimal point, 0.00 to 100.00%	
0070	30113	unsigned int	U: Maximum signal value (P/H U)	No decimal point	
0072	30115	unsigned int	D: Maximum signal value (P/H D)	No decimal point	
0074	30117	int	U: Trigger level (TRG U)	2 places after decimal point, 0.00 to 100.00%	
0076	30119	int	D: Trigger level (TRG D)	2 places after decimal point, 0.00 to 100.00%	
0078	30121	long	U: Maximum signal value (after filter)	No decimal point	
007C	30125	long	D: Maximum signal value (after filter)	No decimal point	
0080	30129	long	Sensor spacing 1	Metric system: 2 places after decimal point, Unit: mm English system: 3 places after decimal point, Unit: inch	

Relative address	Register No.	Data type	Parameter	Read-out data/Write-in data setting range	Remarks
0084	30133	unsigned int	Sensor spacing 2	No decimal point	Cases of FLS_12, FLS_22, FSSA, FSSG, sensors
0086	30135	unsigned char	1st and 2nd characters of version	14 characters of ASCII code	
0088	30137	unsigned char	3rd and 4th characters of version		
008A	30139	unsigned char	5th and 6th characters of version		
008C	30141	unsigned char	7th and 8th characters of version		
008E	30143	unsigned char	9th and 10th characters of version		
0080	30145	unsigned char	11th and 12th characters of version		
0092	30147	unsigned char	13th and 14th characters of version		
0094	30149				Not use
to	to				Not use
00DE	30191	int			Not use

# 8. M-FLOW COMMUNICATION PROTOCOL

## 8.1 General

The communication system by the M-Flow protocol is that the communication is always started from the master station and a slave station responds to the received message.

Transmission procedures is as shown below.

- 1) The master station sends a command message to a slave station.
- 2) The slave station checks that the station No. in the received message matches with the own station No. or not.
- 3) If matched, the slave station executes the command and sends back the response message.
- 4) If mismatched, the slave station leaves the command message and wait for the next command message.

- a) In case when the station No. in the received command message matches with the own slave station No.

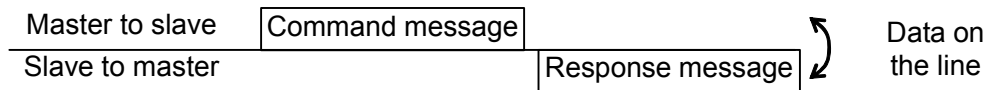

- b) In case when the station No. in the received command message mismatches with the own slave station No.

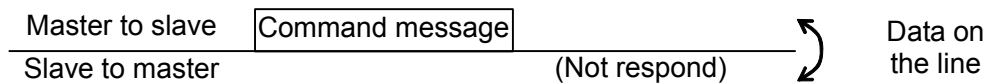

The master station can individually communicate with any one of slave stations connected on the same line upon setting the station No. in the command message.

## 8.2 Message Configuration

### 8.2.1 Reception

Description	Bytes	Remarks
Start mark	1	: (3Ah)
Slave address (SLV)	2	01 to 31
Function code (F_CD)	4	See function code table.
Error check	2	LRC
End mark	1	CR (0Dh)
	1	LF (0Ah)

### 8.2.2 Acknowledge

Description	Bytes	Remarks
Start mark	1	: (3Ah)
Slave address (SLV)	2	01 to 31
Function code (F_CD)	4	See function code table.
Data length (L)	2	
Data	2L	
Error check	2	LRC
End mark	1	CR (0Dh)
	1	LF (0Ah)

### 8.2.3 Error acknowledge

Description	Bytes	Remarks
Start mark	1	: (3Ah)
Slave address (SLV)	2	01 to 31
Function code (F_CD)	4	See function code table.
Error data	2	See error data table.
Error check	2	LRC
End mark	1	CR (0Dh)
	1	LF (0Ah)

Receive format



Acknowledge format

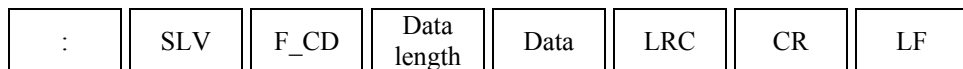

Error acknowledge format

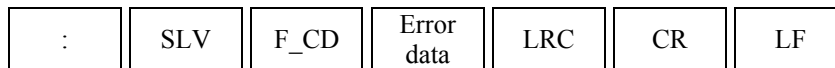

## 8.3 Error Check

Arrange the LRC so that the sum (carry not included) of all ASCII data excluding “:,” “CR” and “LF” will be 00h.

[LRC creation procedure]

- (1) Add the data headed by the start mark (:) excluding the carry.
- (2) Obtain 2's complement for the sum.
- (3) Convert the 2's complement into ASCII (= LRC).

## 8.4 Function Code Table

Description	F_CD	Remarks
Flow velocity	0300	
Flow rate	0310	
Forward integrated value	0320	
Reverse integrated value	0330	
Current output %	0340	
Status	0100	

Note: If an error has occurred, the error acknowledge function code is as follows.  
Function code: 0300 → 8300

## 8.5 Error Code Table

Error data	Remarks
01	Function code error (function code undefined)
02	LRC error
03	Reserve
04	Reserve
05	Reserve

# 9. PC LOADER SOFTWARE IN CD SUPPLIED WITH THE MAIN UNIT

## 9.1 Copyright of This Software

The copyright of this software belongs to Fuji Electric Systems Co., Ltd. No part of this software may be reproduced or transmitted in any form.

## 9.2 Outline

Using this software, you can set, read and display relevant graphs of this instrument on your PC with ease. Your data can be easily edited with Microsoft Excel because you can save your data in CSV file format.

Note: Microsoft Excel is the registered Trademark of the Microsoft Corporation in the United States.

## 9.3 PC to Be Used

### 9.3.1 Computer

AT compatible-type with CPU Pentium IV 1 GHz/Celeron 1 GHz or more installed, display resolution of 1024 × 768, and use of small font recommended.

### 9.3.2 Memory capacity

128 MB or more (256 MB or more recommended) [52 MB memory or more for free space required]

### 9.3.3 Interface

RS232C port or RS485 port, MODBUS communication protocol

### 9.3.4 OS

Microsoft Windows2000 Professional (SP6a or more) or Microsoft WindowsXP Professional (SP1 or more) or Microsoft Windows7 (Home Premium, Professional)

## 9.4 Installing of Software

- (1) Insert the setup disk into the drive, and double-click “UltrasonicFlowmeter2\_eng.msi.”



Fig. 9-1 <Install file>

- (2) Setting wizard will start up. Click the [Next] button. Click the [Cancel] button to cancel the installation.



Fig. 9-2 < Setup wizard screen >

- (3) There is a query about selection of installation folder. Click the [Next] button to install the software in that folder. To specify a folder click the [Browse] button and select, or enter directly. To return to the previous screen, click the [Previous] button. Click the [Cancel] button to cancel the installation.

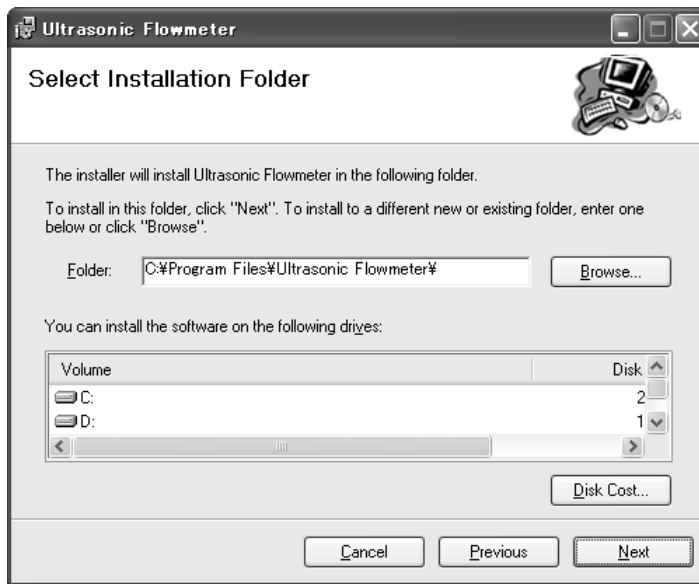

Fig. 9-3 < Select installation folder screen >

- (4) Screen is displayed to confirm installation. Click the [Next] button to execute the installation. Click the [Previous] button to return to the previous screen. Click the [Cancel] button to cancel the installation.

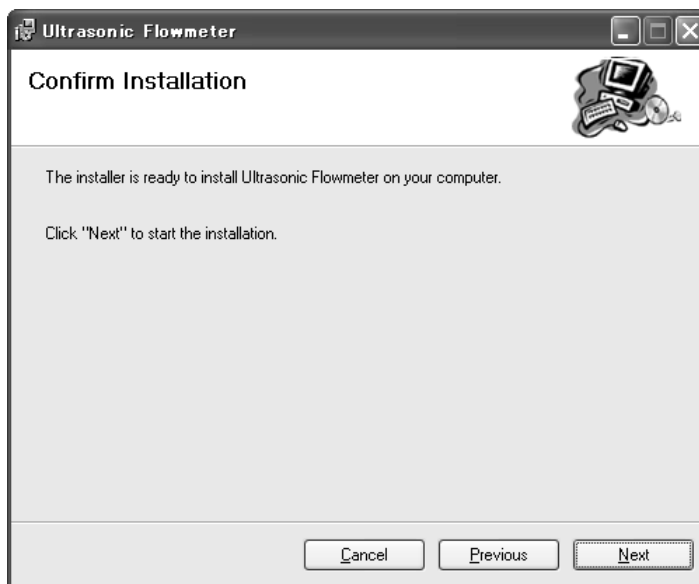

Fig. 9-4 < Installation confirmation screen >



(5) Execution of Installation

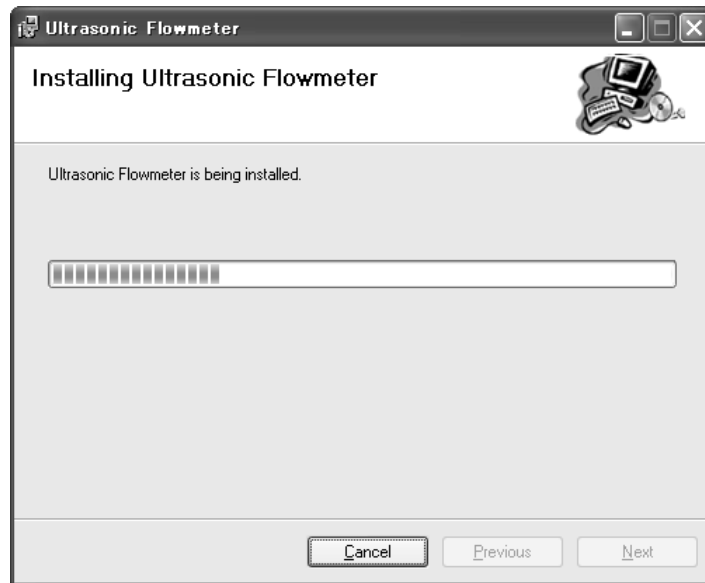

Fig. 9-5 < Installing screen >

(6) The Installation Complete screen is displayed. Click the [Close] button to exit the installation screen.

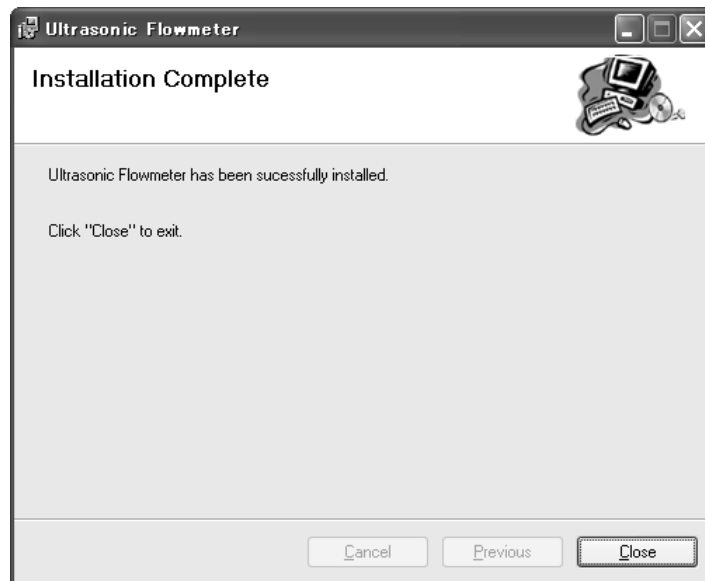

Fig. 9-6 < Installation complete screen >

(7) After installation, the start menu and the application (“Ultrasonic Flowmeter2”) that has been installed in the desktop are created.

## 9.5 Startup Method

Start “Ultrasonic Flowmeter2” from the start menu or the shortcut menu to start up the loader.



Fig. 9-7 < Start screen >

Information related to system name, measuring method, language and unit can be obtained by communicating with the flow transmitter.

If error occurs during communications, an error message is displayed to continue communication, select [Continue]. To stop communication, select [Cancel] on the menu screen that appears, check the setting for “Communication.”

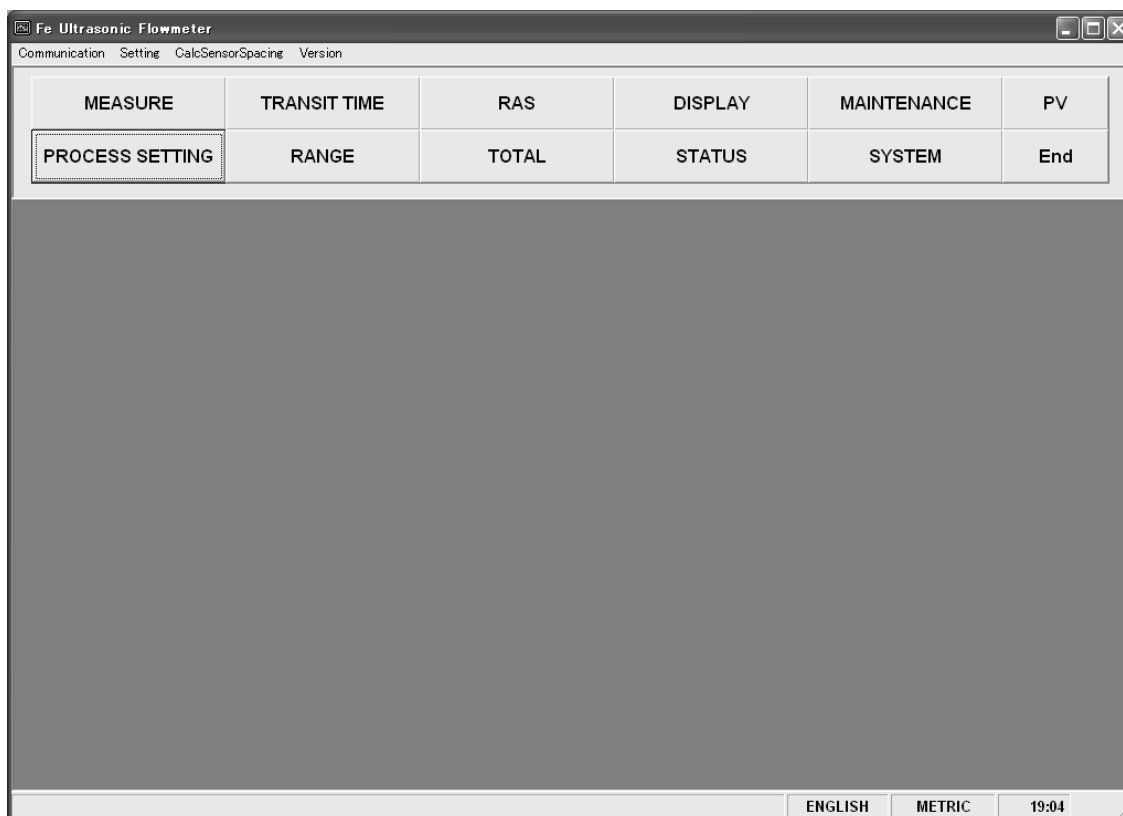

Fig. 9-8 < Menu screen >

Click the menu bar and each function button to execute a desired function.

Note: When communication cables are removed and then reconnected, restart the loader software.

## 9.5.1 Communications

Click “Communication” on the menu bar on the Menu screen, and the following setup screen appears.

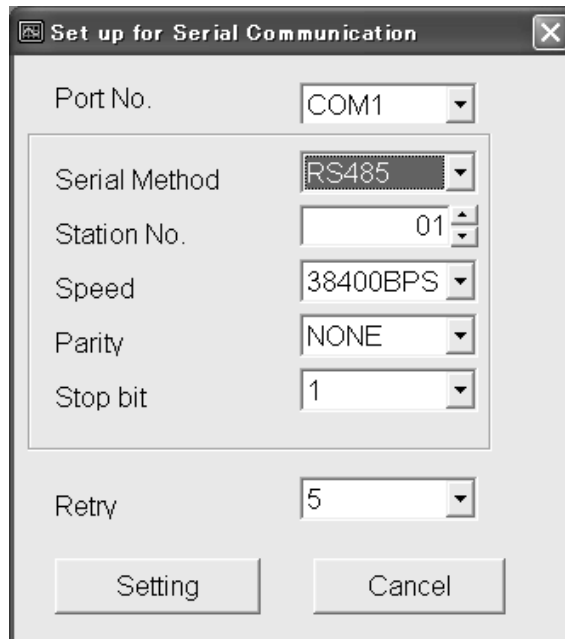

Fig. 9-9 < Serial communication setup screen >

Click the [Setting] button, and setting content is reflected; communications are executed with the flow transmitter and information related to system name, measurement method, language and unit is obtained. Click the [Cancel] button to invalidate the setting.

Table 9-1 <Measurement and Detailed Setting>

Item	Content
Port No.	Select either from COM1, COM2, COM3, COM4 and COM5.
Serial Method	Select RS485.
Station No.	Select one from 01 to 31. If communication method is RS232C, no selection is allowed (fixed with 00).
Speed	Select one from 9600BPS, 19200BPS and 38400BPS.
Parity	Select one from NONE, EVEN and ODD.
Stop Bit	Select either 1-bit or 2-bit.
Retry	Specify in the range from 0 to 5.

## 9.5.2 Setting

Click “Setting” on the menu bar on the Menu screen, and either “Save setting” or “Read setting” can be selected.

### 9.5.2.1. Save setting

Click “Save Setting”, and the following screen appears. Specify saving location and file name, and setting content is saved by clicking [Save] button. Click the [Cancel] button not to save the setting. File format is ini file.

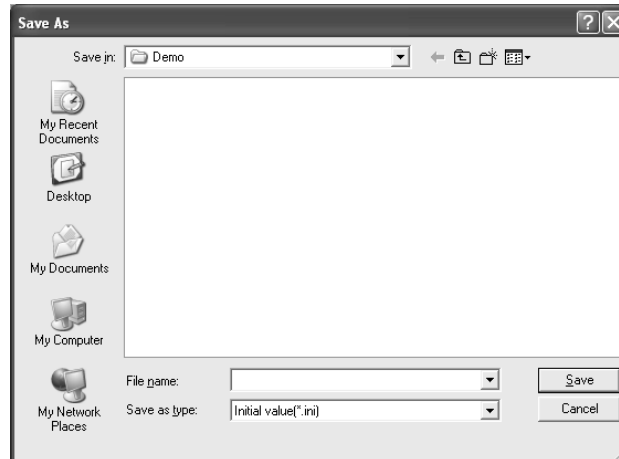

Fig. 9-10 < Save setting: select save file screen >

\* Note: Please be careful not to rewrite the setting file for loader (Hybrid USF.ini).

### 9.5.2.2. Read setting

Click “Read Setting”, and the following screen appears. Specify the location and the name of the file saved previously. Click the [Open] button to read the setting. Click the [Cancel] button not to read the setting. File format is ini file.

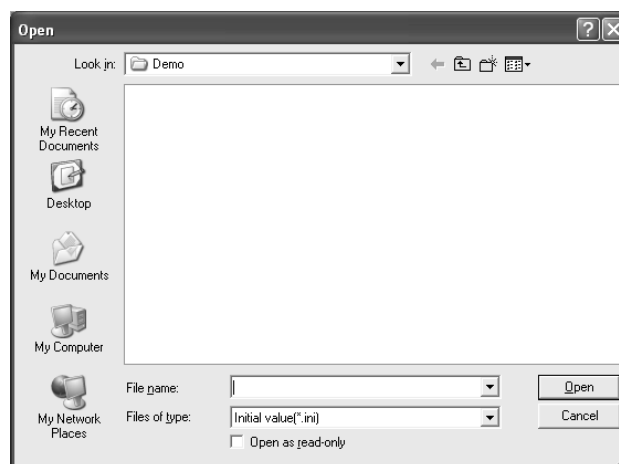

Fig. 9-11 < Read setting: select read file screen >

### 9.5.3 Calculation Sensor Spacing

On the menu screen, click [Calculation Sensor Spacing] of the menu bar, and the following screen appears. This function can be used even when connection with the main unit is not established for communication.

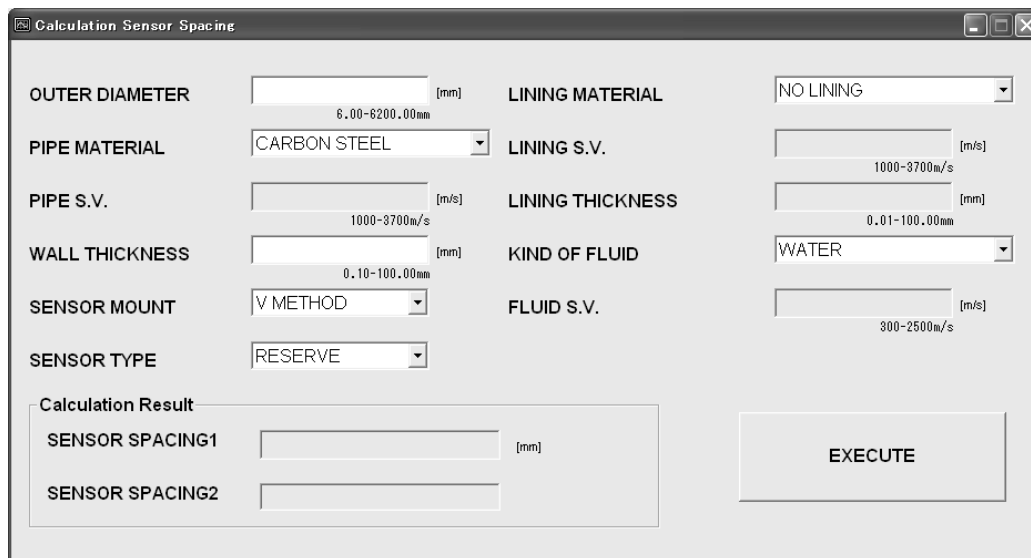

Fig. 9-12 < Calculation sensor spacing >

See Table 9-2 for details of calculation sensor spacing.

[Execute] button ..... Calculates and displays sensor spacing 1 and 2 based on the input values.

Note: The values after the decimal point may differ from those of the main unit depending on the accuracy of calculation.

Table 9-2 < What to Enter >

Item	Content
OUTER DIAMETER	Enter in the range from 6.00 to 6200.00 mm (two decimal places) for metric system, and from 0.2362 to 244.1000 inch (four decimal places) for inch system.
PIPE MATERIAL	Select from carbon steel, stainless steel, PVC, copper, cast iron, aluminum, FRP, ductile iron, PEEK, PVDF, acrylic, PP, and pipe S.V.
PIPE SOUND VELOCITY	Enter in the range from 1000 to 3700 m/s (no decimal point) for metric system and from 3280 to 12140 ft/s (no decimal point) for inch system. (If “Pipe S.V.” is selected as piping material.)
WALL THICKNESS	Enter in the range from 0.10 to 100.00 mm (two decimal places) for metric system, and from 0.0039 to 3.9380 inch (four decimal places) for inch system.
LINING MATERIAL	Select from no lining, tar epoxy, mortar, rubber, Teflon, pyrex glass, PVC and lining S.V.
LINING SOUND VELOCITY	Enter in the range from 1000 to 3700 m/s (no decimal point) for metric system, and from 3280 to 12140 ft/s (no decimal point) for inch system. (If “Lining S.V.” is selected as lining material”.)
LINING THICKNESS	Enter in the range from 0.01 to 100.00 mm (two decimal places) for metric system, and 0.0003 to 3.9380 inch (four decimal places) for inch system. (If “No lining” is selected as lining material.)
KIND OF FLUID	Select for water, seawater, dist. water, ammonia, alcohol, benzene, bromide, ethanol, glycol, kerosene, milk, methanol, toluene, lube oil, fuel oil, petrol, coolant R410, and fluid S.V.
FLUID S.V.	Enter in the range from 300 to 2500 m/s (no decimal point) for metric system, and from 984 to 8203 ft/s (no decimal point) for inch system. (If “Fluid S.V.” is selected as fluid type”).
SENSOR MOUNT	Select from V method and Z method.
SENSOR TYPE	Select from FSSA/FSSG, FLS_12/FLS_22, FSSC, FSG_32, FSG_31/FSG_41, FSSE/FSG_50, FSSF/FSG_51, FSD12, FSSD/FSD22, FSSH/FSD32
SENSOR SPACING 1	Displays the calculation result of sensor spacing 1.
SENSOR SPACING 2	Displays the calculation result of sensor spacing 2. (If FLS_12, FLS_22, FSSA or FSSG is selected as sensor type.)

## 9.5.4 Version

Click “Version” on the menu bar on the Menu screen, and the following screen appears.



\* The version number at left is a display example.

Fig. 9-13 < Version screen >

Click the [OK] button to close the screen.

## 9.6 Structure of Function

Functions with loader are as follows:

Table 9-3 < Function >

Function	Outline
PROCESS	Sets piping specifications, sensor type, etc.
RANGE	Sets range-related matters.
TOTAL	Sets total-related matters.
STATUS	Sets status output-related matters.
DISPLAY	Sets LCD display-related matters.
SYSTEM	Sets system related to language, etc.
MEASURE	Displays trend of flow rate, etc.
TRANSIT TIME	Displays graphs on detailed setting of transit time difference, operation information and received waveform, etc.
RAS	Read-in RAS.
MAINTENANCE	Conducts AO adjustment and AO/DO test.
PV	Measures station No. 1 to No. 31. Available only when RS485 communication.

## 9.7 Process Setting

Click the “PROCESS SETTING” button on the Menu screen, and the following screen appears.

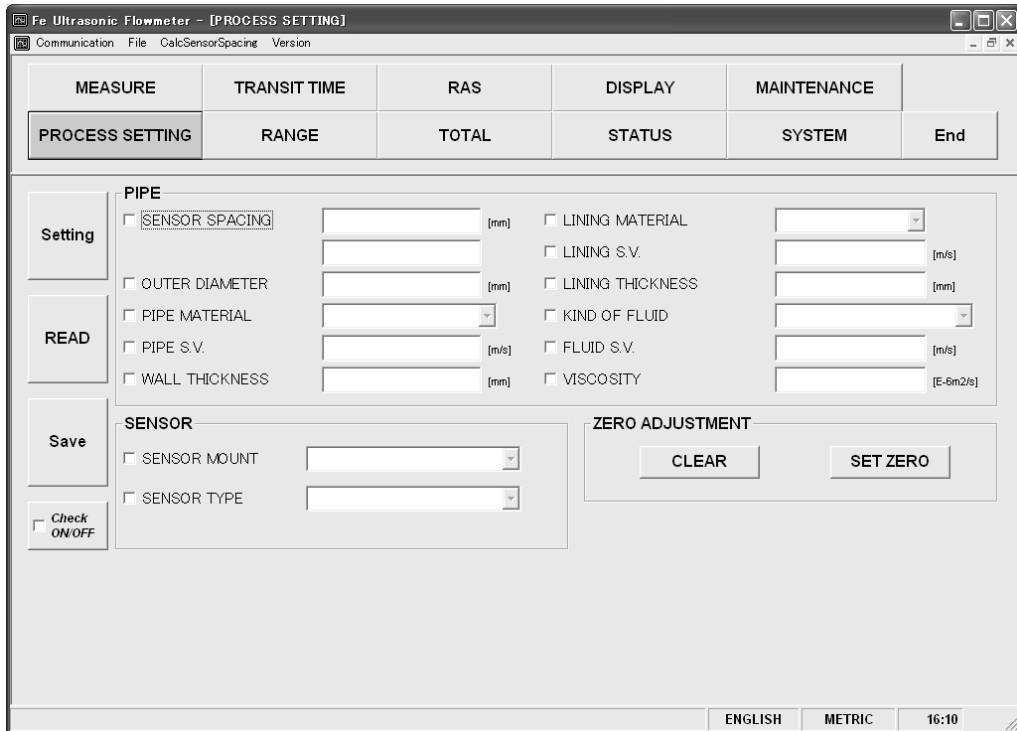

Fig. 9-14 < Process setting screen >

To select an item to be set or read, set the relevant check box to ON (☑). Not to select (or to reset the selection), set the relevant check box to OFF (☐). If “Other” is selected as pipe material, pipe sound velocity becomes valid. For details of “Process setting,” refer to Tables 9-4 and 5 on the next page.

- Pipe material: Items other than PIPE S.V.  
Display invalid..... PIPE S.V.
- Pipe material: PIPE S.V.  
Display valid..... PIPE S.V.
- Lining material: Without lining  
Display invalid..... LINING S.V., LINING THICKNESS
- Lining material: Without lining, Items other than LINING S.V.  
Display valid..... LINING THICKNESS  
Display invalid..... LINING S.V.
- Lining material: LINING S.V.  
Display valid..... LINING S.V., LINING THICKNESS
- Kind of fluid: For items other than FLUID S.V.  
Display invalid..... FLUID S.V.
- Kind of fluid: FLUID S.V.  
Display valid..... FLUID S.V.

- [Setting].....Sends the setting of the selected item (check box set to ON ()), reflecting the response value on the setting.
- [READ] .....Reads the setting of the selected item (check box set to ON ()), reflecting the response value on the setting.
- [Save] .....Reflects the setting sent by pressing the [Setting] button on the flow transmitter. Be sure to press the [Save] button if the setting is changed.
- [Check ON/OFF].....Set the check box to ON to select all the items (to set all the check boxes to ON ()). Set the check box to OFF () to release the selection of all the items (to set all the check boxes to OFF ()).
- [CLEAR] .....Clears zero calibration.
- [SET ZERO].....Executes zero calibration adjustment.

Table 9-4 < Piping Specifications >

Item	Content
OUTER DIAMETER	Enter in the range from 6.00 to 6200.00 mm (two decimal places) for metric system, and from 0.2362 to 244.1000 inch (four decimal places) for inch system.
PIPE MATERIAL	Select from carbon steel, stainless steel, PVC, copper, cast iron, aluminum, FRP, ductile iron, PEEK, PVDF, acrylic, PP, and pipe S.V.
PIPE SOUND VELOCITY	Enter in the range from 1000 to 3700 m/s (no decimal point) for metric system and from 3280 to 12140 ft/s (no decimal point) for inch system. (If “Pipe S.V.” is selected as piping material.)
WALL THICKNESS	Enter in the range from 0.10 to 100.00 mm (two decimal places) for metric system, and from 0.0039 to 3.9380 inch (four decimal places) for inch system.
LINING MATERIAL	Select from no lining, tar epoxy, mortar, rubber, Teflon, pyrex glass, PVC and lining S.V.
LINING SOUND VELOCITY	Enter in the range from 1000 to 3700 m/s (no decimal point) for metric system, and from 3280 to 12140 ft/s (no decimal point) for inch system. (If “Lining S.V.” is selected as lining material”.)
LINING THICKNESS	Enter in the range from 0.01 to 100.00 mm (two decimal places) for metric system, and 0.0003 to 3.9380 inch (four decimal places) for inch system. (If “No lining” is selected as lining material.)
KIND OF FLUID	Select for water, seawater, dist. water, ammonia, alcohol, benzene, bromide, ethanol, glycol, kerosene, milk, methanol, toluene, lube oil, fuel oil, petrol, coolant R410, and fluid S.V.
FLUID S.V.	Enter in the range from 300 to 2500 m/s (no decimal point) for metric system, and from 984 to 8203 ft/s (no decimal point) for inch system. (If “Fluid S.V.” is selected as fluid type”).
VISCOSITY	Enter in the range from 0.001 to 999.999 E-6 m <sup>2</sup> /s for metric system, and from 0.0107 to 10764 E-6 ft <sup>2</sup> /s for inch system.
SENSOR SPACING	[Read] only is valid.

Table 9-5 < System >

Item	Content
SENSOR MOUNT	Select from Z method and V method.
SENSOR TYPE	Select from FSSA/FSSG, FLS_12/FLS_22, FSSC, FSG_32, FSG_31/FSG_41, FSSE/FSG_50, FSSF/FSG_51, FSD12, FSSD/FSD22, FSSH/FSD32



## 9.8 Range Setting

Click the “RANGE” button on the Menu screen, and the following screen appears.

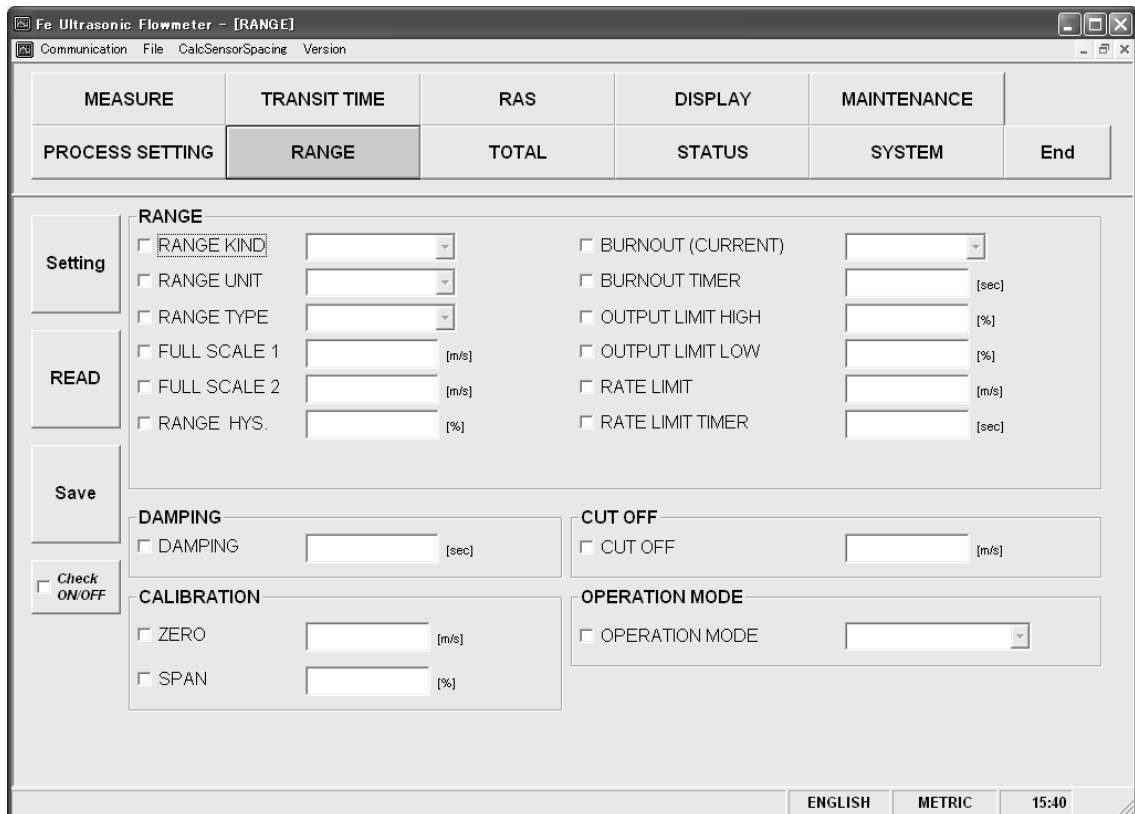

Fig. 9-15 < Range setting screen >

To select an item to be set or read, set the relevant check box to ON (☑). Not to select (or to reset the selection), set the relevant check box to OFF (☐). For details of “Range setting,” refer to Tables 9-6 to 9-10 on the next page.

- Type: in case of single range;  
Display Valid..... Full scale 1  
Display Invalid..... Full scale 2 and hysteresis
- Type: in case of automatic 2-range, forward and reverse range, forward and reverse automatic 2-range  
Display Valid..... Full scale 1, full scale 2 and hysteresis  
Display Invalid..... None

[Setting].....Sends the setting of the selected item (check box set to ON (☑)), reflecting the response value on the setting.

[READ] .....Reads the setting of the selected item (check box set to ON (☑)), reflecting the response value on the setting.

[Save] .....Reflects the setting sent by pressing the [Setting] button on the flow transmitter. **Be sure to press the [Save] button if the setting is changed.**

[Check ON/OFF].....Set the check box to ON to select all the items (to set all the check boxes to ON (☑)). Set the check box to OFF (☐) to release the selection of all the items (to set all the check boxes to OFF (☐)).

Table 9-6 &lt; Range Setting &gt;

Item	Content
KIND OF RANGE	Velocity, Flow rate
RANGE UNIT	Select from L/s, L/min, L/h, L/d, kL/d, ML/d, m <sup>3</sup> /s, m <sup>3</sup> /min, m <sup>3</sup> /h, m <sup>3</sup> /d, k m <sup>3</sup> /d, M m <sup>3</sup> /d, BBL/s, BBL/min, BBL/h, BBL/d, kBBL/d, MBBL/d [ft <sup>3</sup> /s, ft <sup>3</sup> /min, ft <sup>3</sup> /h, ft <sup>3</sup> /d, kft <sup>3</sup> /d, Mft <sup>3</sup> /d, gal/s, gal/min, gal/h, gal/d, kgal/d, Mgal/d, BBL/s, BBL/min, BBL/h, BBL/d, kBBL/d, MBBL/d]* Of which [ ]: unit is in case of inch system.
RANGE TYPE	Select from SINGLE, AUTO 2, BI-DIR, BI-DIR AUTO 2.
FULL SCALE 1	Enter 0, ±0.3 to 32 m/s fitting value (comply with range unit).
FULL SCALE 2	Enter 0, ±0.3 to 32 m/s fitting value (comply with range unit).
HYSTERISIS	Enter in the range of 0.00 to 20.00%. (2 places after decimal point)
OUTPUT LIMIT LOW	Enter in the range of -20 to 0%.
OUTPUT LIMIT HIGH	Enter in the range of 100 to 120%.
OUTPUT BURNOUT	Select from NOT USED, HOLD, UPPER, LOWER, ZERO.
BURNOUT TIMER	Enter in the range of 0 to 900sec.
RATE LIMIT	Enter 0 to 5 m/s fitting value (comply with range unit).
RATE LIMIT TIMER	Enter in the range of 0 to 900 sec.

Table 9-7 &lt; Damping &gt;

Item	Content
DAMPING	Enter in the range of 0.0 to 100.0 sec. (1 place after decimal point)

Table 9-8 &lt; Low Flow Rate Cut &gt;

Item	Content
CUT OFF	Enter 0 to 5 m/s fitting value (comply with range unit).

Table 9-9 &lt; Output Correction &gt;

Item	Content
ZERO	Enter -5 to 5 m/s fitting value (comply with range unit).
SPAN	Enter in the range of ±200.00%. (2 places after decimal point)

Table 9-10 &lt; Operation Mode &gt;

Item	Content
OPERATION MODE	Select from NORMAL, HIGH SPEED.

## 9.9 Total Setting

Click the “TOTAL” button on the Menu screen, and the following screen appears.

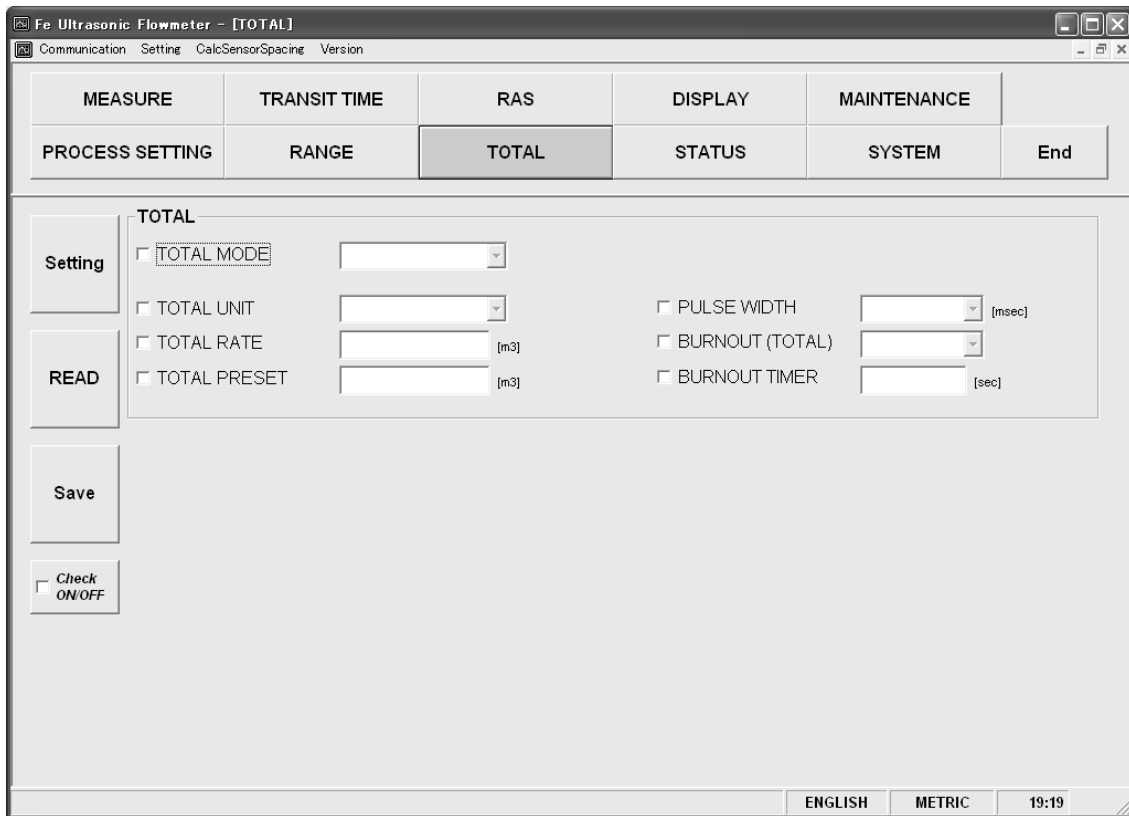

Fig. 9-16 < Total setting screen >

To select an item to be set or read, set the relevant check box to ON (☑). Not to select (or to reset the selection), set the relevant check box to OFF (☐). For details of “Total setting,” refer to Table 9-11 on the next page.

- Mode: in case of start and reset;  
Display invalid..... Unit, constant, total preset, pulse width
- Mode: in case of stop;  
Display valid ..... Unit, constant, total preset, pulse width

[Setting] .....Sends the setting of the selected item (check box set to ON (☑)), reflecting the response value on the setting. Note that only when “STOP” mode is selected, the setting of unit, constant, total preset, pulse width is reflected.

[READ] .....Reads the setting of the selected item (check box set to ON (☑)), reflecting the response value together with the unit on the setting.

[Save] .....Reflects the setting sent by pressing the [Setting] button on the flowmeter flow transmitter.  
Be sure to press the [Save] button if the setting is changed.

[Check ON/OFF] .....Set the check box to ON (☑) to select all the items (to set all the check boxes to ON (☑)).  
Set the check box to OFF (☐) to release the selection of all the items (to set all the check boxes to OFF (☐)).

Table 9-11 < Total Setting >

Item	Content
TOTAL MODE	Select from TOTAL STOP, TOTAL RUN, TOTAL RESET.
TOTAL UNIT	Select from mL, L, m <sup>3</sup> , km <sup>3</sup> , Mm <sup>3</sup> , mBBL, BBL and kBBL, [ft <sup>3</sup> , kft <sup>3</sup> , Mft <sup>3</sup> , kgal, gal, mBBL, BBL, kBBL and ACRf]* Of which [ ]: unit is in case of inch system.
TOTAL RATE	Enter in the range of 0 to 99999999 fitting value. (comply with total unit)
TOTAL PRESET	Enter in the range of 0 to 99999999 fitting value. (comply with total unit)
PLUSE WIDTH	Select from 5.0, 10.0, 50.0, 100.0, 200.0, 500.0, 1000.0 msec
OUTPUT BURNOUT	Select from NOT USED and HOLD.
BURNOUT TIMER	Enter in the range of 0 to 900 sec.

Note: When unit is changed, each unit indication of constant and total preset is changed if [Read] is executed.

Note: When setting of the unit, constant, total preset, and pulse width is changed, it should be executed with the mode stop.

## 9.10 Status Output Setting

Click the “STATUS” button on the Menu screen, and the following screen appears.

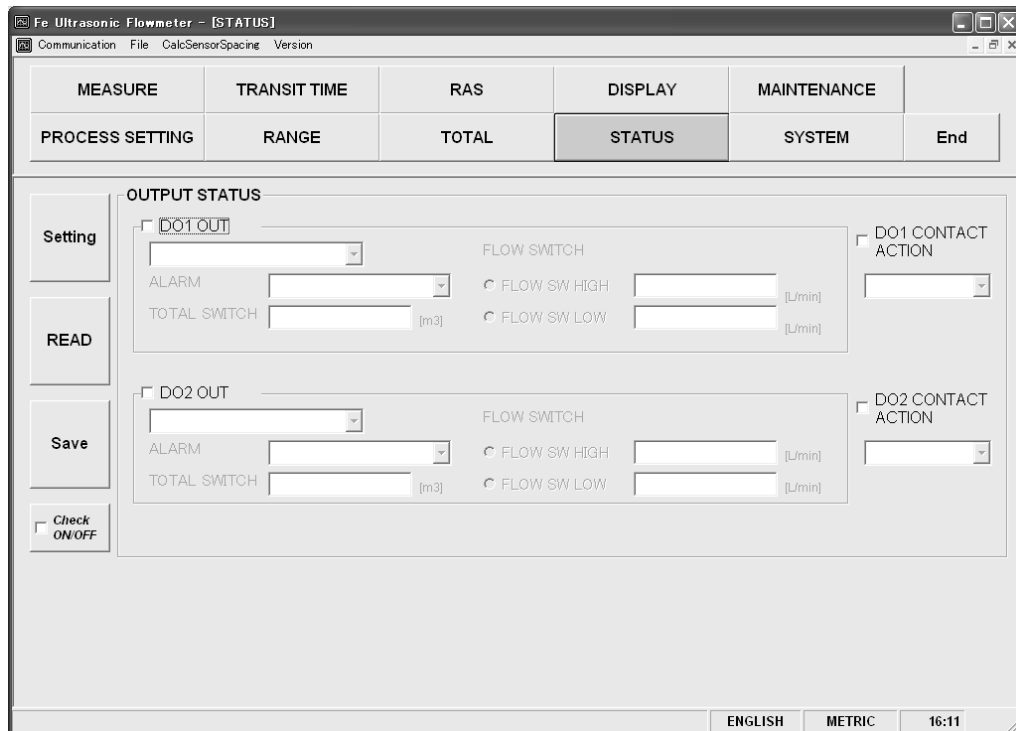

Fig. 9-17 < Status output setting screen >

To select an item to be set or read, set the relevant check box to ON (☑). Not to select (or to reset the selection), set the relevant check box to OFF (☐). For details of “Status output setting,” refer to Tables 9-12 and 9-13 on the next page.

- DO1, DO2 output: Items other than alarm, flow rate switch, and total switch  
Display invalid..... Alarm, flow rate switch (Flow switch High/Flow switch Low), total switch
- DO1, DO2 output: Alarm  
Display valid..... Alarm  
Display invalid..... Flow rate switch (Flow switch High/Flow switch Low) , total switch
- DO1, DO2 output: Flow rate switch  
Display valid..... Flow rate switch (Flow switch High/Flow switch Low)  
Display invalid..... Alarm, total switch
- DO1, DO2 output: Total switch  
Display valid..... Total switch  
Display invalid..... Alarm, flow rate switch (Flow switch High/Flow switch Low)

[Setting].....Sends the setting of the selected item (check box set to ON (☑)), reflecting the response value on the setting.

[READ].....Reads the setting of the selected item (check box set to ON (☑)), reflecting the response value on the setting.

[Save].....Reflects the setting sent by pressing the [Setting] button on the flow transmitter. Be sure to press the [Save] button if the setting is changed.

[Check ON/OFF]..... Set the check box to ON to select all the items (to set all the check boxes to ON (☑)). Set the check box to OFF (☐) to release the selection of all the items (to set all the check boxes to OFF (☐)).

Table 9-12 < Status output setting >

Item		Content
DO1	Output	Select from Not use, + Total pulse, – Total pulse, Full scale 2, Alarm, Flow switch, Total switch, AO range over, Pulse range over, and – Flow direction.
	Alarm	Select from All, Hardware error, and Process error (when alarm is selected for DO1 output).
	Flow rate switch	Select from Upper flow rate limit (Flow switch High) and Lower flow rate limit (Flow switch Low) (when flow rate switch is selected for DO1 output).
	Flow switch High	Enter in the range from 0 to 32 m/s or equivalent. (Use the same unit as the range unit.)
	Flow switch Low	Enter in the range from 0 to 32 m/s or equivalent. (Use the same unit as the range unit.)
	Total switch	Enter in the range from 0 to 99999999. (Use the same unit as the total unit.)
DO2	Output	Select from Not use, + Total pulse, – Total pulse, Full scale 2, Alarm, Flow switch, Total switch, AO range over, Pulse range over, and – Flow direction.
	Alarm	Select from All, Hardware error, and Process error (when alarm is selected for DO1 output).
	Flow rate switch	Select from Upper flow rate limit (Flow switch High) and Lower flow rate limit (Flow switch Low) (when flow rate switch is selected for DO1 output).
	Upper flow rate limit (Flow switch High)	Enter in the range from 0 to 32 m/s or equivalent. (Use the same unit as the range unit.)
	Lower flow rate limit (Flow switch Low)	Enter in the range from 0 to 32 m/s or equivalent. (Use the same unit as the range unit.)
	Total switch	Enter in the range from 0 to 99999999. (Use the same unit as the total unit.)
DO1 contact operation		Select ON at operation or OFF at operation.
DO2 contact operation		Ditto

# 9.11 Display Setting

Click the “DISPLAY” button on the Menu screen, and the following screen appears.

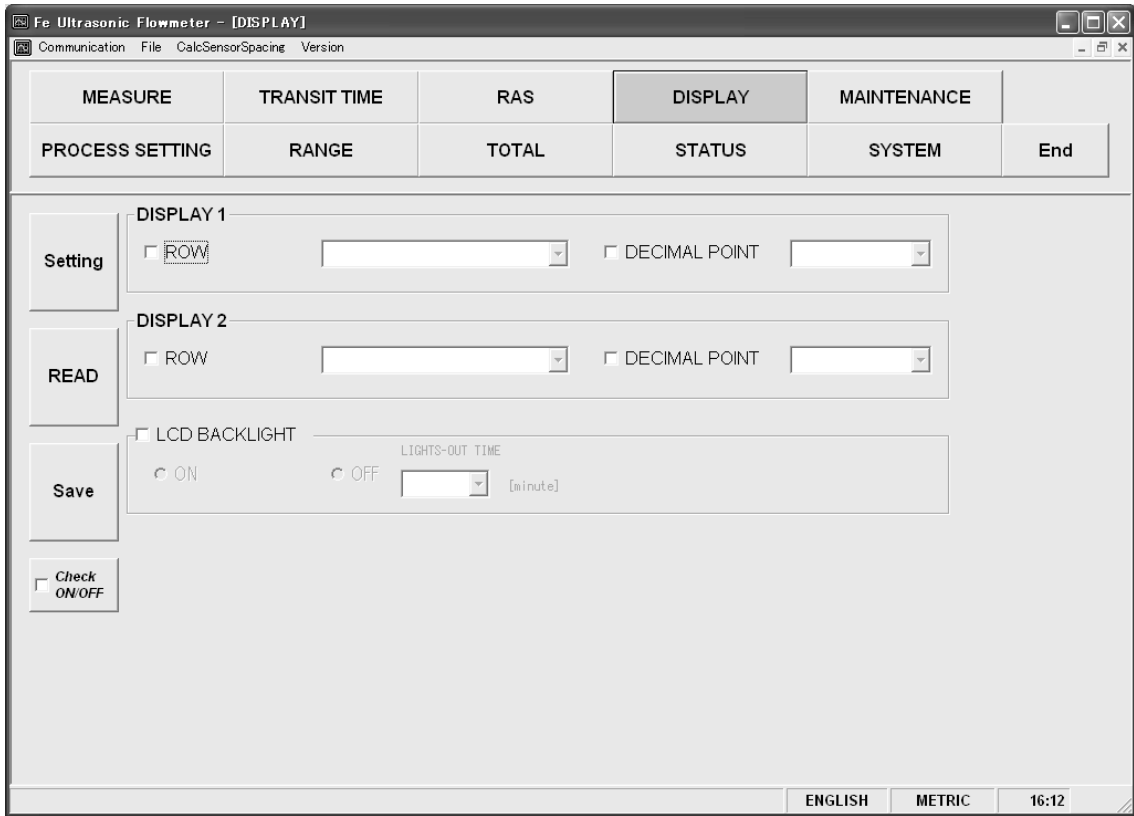

Fig. 9-18 < Display setting screen >

To select an item to be set or read, set the relevant check box to ON (☑). Not to select (or to reset the selection), set the relevant check box to OFF (☐). For details of “Display setting,” refer to Table 9-13.

- Display 1, 2 selection: In case of velocity, + total pulse, – total pulse  
Display invalid..... Decimal point

[Setting] .....Sends the setting of the selected item (check box set to ON (☑)), reflecting the response value on the setting.

[READ] .....Reads the setting of the selected item (check box set to ON (☑)), reflecting the response value on the setting.

[Save] .....Reflects the setting sent by pressing the [Setting] button on the flowmeter flow transmitter. Be sure to press the [Save] button if the setting is changed.

[Check ON/OFF] .....Set the check box to ON to select all the items (to set all the check boxes to ON (☑)). Set the check box to OFF (☐) to release the selection of all the items (to set all the check boxes to OFF (☐)).

Table 9-13 &lt; Display Setting &gt;

Item		Content
DISPLAY 1	Selection	Select from VELOCITY, FLOW RATE, + TOTAL (ACTUAL), - TOTAL (ACTUAL), + TOTAL PULSE, - TOTAL PULSE.
	Decimal Point Position	0: *.*****, 1: **.*****, 2: ***.****, 3: ****.***, 4: *******, 5: ******, 6: *****.
DISPLAY 2	Selection	Same as the selection of DISPLAY 1
	Decimal Point Position	Same as the decimal point position of DISPLAY 1
LCD BACKLIGHT	Selection	Select from ON, OFF
	Light off time	0 to 99 min



## 9.12 System Setting

Click the “SYSTEM” button on the Menu screen, and the following screen appears.

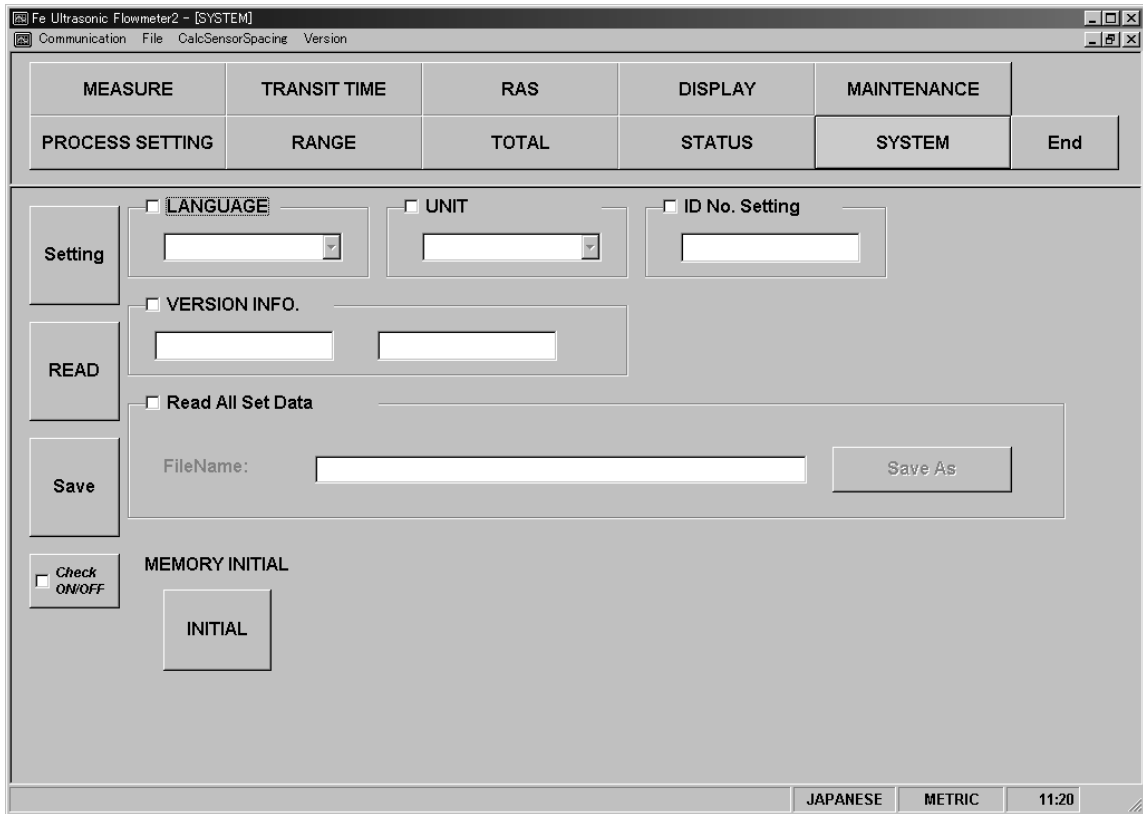

Fig. 9-19 < System setting screen >

To select an item to be set or read, set the relevant check box to ON (☑). Not to select (or to reset the selection), set the relevant check box to OFF (☐). However, system name and version information can only be read. For details of “System setting,” refer to Table 9-14.

- [Setting] .....Sends the setting of the selected item (check box set to ON (☑)), reflecting the response value on the setting.
- [READ] .....Reads the setting of the selected item (check box set to ON (☑)), reflecting the response value on the setting.
- [Save] .....Reflects the setting sent by pressing the [Setting] button on the flow transmitter. Be sure to press the [Save] button if the setting is changed.
- [Check ON/OFF] .....Set the check box to ON (☑) to select all the items (to set all the check boxes to ON (☑)). Set the check box to OFF (☐) to release the selection of all the items (to set all the check boxes to OFF (☐)). \* Note that the Read-in All Set Data check box cannot be checked (☑ not allowed).
- [INITIAL] button .....Returns all the settings of the flowmeter to the initial state.

Table 9-14 < System Setting >

Item	Content
LANGUAGE	Language is available in ENGLISH, JAPANESE, GERMAN, FRENCH and SPANISH.
UNIT SYSTEM	Select from METRIC and ENGLISH.
ID No. Setting	Enter in rage of 0000 to 9999.
Version information	Read only
Read All Set Data	Outputs all the settings of the flowmeter to a designated file in CSV format.

## 9.13 Measurement

Click the “MEASURE” button on the Menu screen, and the following screen appears.

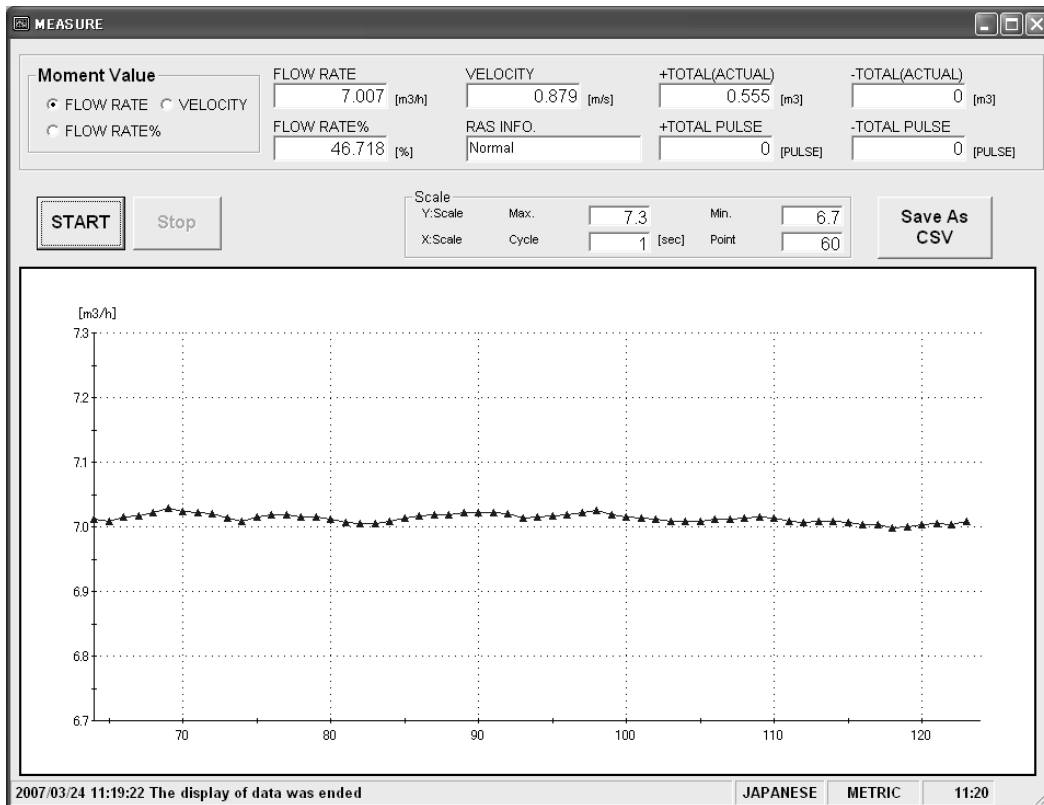

Fig. 9-20 < Measure screen >

Select Instantaneous value from Flow rate, Flow rate% and velocity first.

Then click the [SRART] button, and the value is read-in, and the flow rate, flow rate %, velocity, RAS, + Total, + Total pulse, – Total, and – Total pulse are updated in the specified cycles. The trend is also displayed. (Time of collection is displayed on the X-axis, and the data is deleted and time shifted when specified number of points is reached, allowing the latest value to be viewed.) The vertical axis is displayed in specified Y scale.

See Table 9-15 for details of measurement.

[Start]..... Starts measuring. When setting of saving file is completed with [Save as CSV] button, [Start] button will be enabled to click.

[Stop]..... Stops measuring.

[Save as CSV] .....Click the button, and you are prompted to enter the name of a file to which the data is to be saved. Specify the destination to save and enter the file name, and a CSV format file is created. When click the [Save as CSV], you are asked the file name where to save and then input the destination and file name to save, and file in CSV format will be created.

When setting of saving file is completed, [Start] button will be enabled to click.

When the number of data in the saving file exceeds 32000 line, new file will be created separately.

Year, month, date, hour, minute, and second part of the file name will be changed when the file are updated automatically.

Note) When amount of the data to be saved on the file exceeds 32000 lines, new file will be created automatically.

Please make sure that PC hard disc has space to save the data.

e.g.) Setting of file name YYYYMMDDHHMMSS

Year, Month, Day, Hour, Minute, Second

Table 9-15 < Measurement/Detailed Setting >

Item		Content
Instantaneous value		Select from Flow rate, Flow rate %, and Velocity.
Flow rate		Read-in only
Flow rate %		Read-in only
Velocity		Read-in only
RAS		Read-in only
+Total		Read-in only
-Total		Read-in only
Scale	Y scale	Enter the maximum and minimum values.
	X scale	Enter cycles and number of points. Enter cycles in the range from 1 to 3600.

## 9.14 Transit Time Difference Measurement

Click the [TRANSIT TIME] button on the Menu screen, and the following screen appears. Click detailed setting tab, receiving waveform tab and operation information tab when necessary.

### 9.14.1 Detailed Setting

#### CAUTION

- Do not change the setting by yourself. Otherwise measurement may be disabled.
- Make the detailed setting only when a problem should arise in flow rate measurement with factory default settings. The setting need not be made in other cases.

Click “DETAILS”, and the following screen appears.

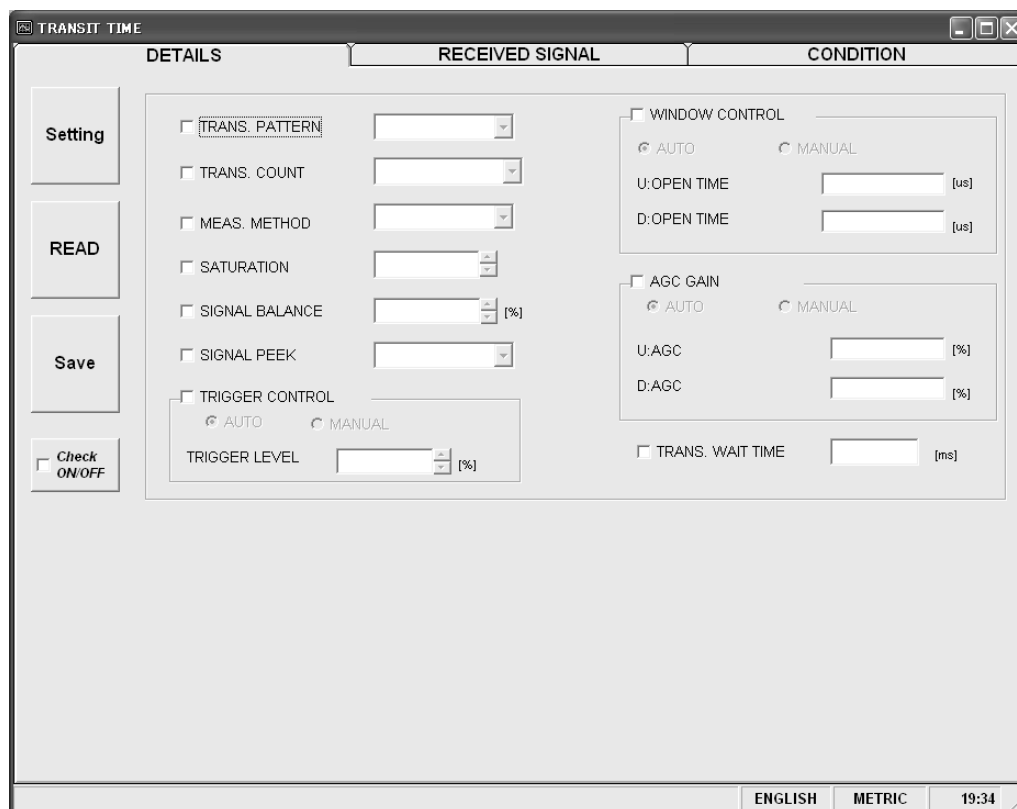

The screenshot shows the 'TRANSIT TIME' software interface. The 'DETAILS' tab is selected, showing various configuration options. On the left, there are buttons for 'Setting', 'READ', 'Save', and 'Check ON/OFF'. The main area is divided into three sections: 'DETAILS', 'RECEIVED SIGNAL', and 'CONDITION'. The 'DETAILS' section includes checkboxes for 'TRANS. PATTERN', 'TRANS. COUNT', 'MEAS. METHOD', 'SATURATION', 'SIGNAL BALANCE', 'SIGNAL PEEK', and 'TRIGGER CONTROL'. The 'RECEIVED SIGNAL' and 'CONDITION' sections include checkboxes for 'WINDOW CONTROL', 'AGC GAIN', and 'TRANS. WAIT TIME'. The bottom right corner shows 'ENGLISH', 'METRIC', and '19:34'.

Fig. 9-21 < Detailed information screen >

Select the items to be set or read-in by checking the check box of the desired items (☑). Make the check box of the items not to be selected (or to be canceled) blank (☐).

See Table 9-16 on the next page for the details of the setting.

- [Setting].....Sends the setting of the selected item (check box set to ON (☑)), reflecting the response value on the setting.
- [READ] .....Reads the setting of the selected item (check box set to ON (☑)), reflecting the response value on the setting.
- [Save] .....Reflects the setting sent by pressing the [Setting] button on the flow transmitter. Be sure to press the [Save] button if the setting is changed.
- [Check ON/OFF].....Set the check box to ON to select all the items (to set all the check boxes to ON (☑)). Set the check box to OFF (☐) to release the selection of all the items (to set all the check boxes to OFF (☐)).

Table 9-16 < Detailed Setting >

Item	Content
TRANSMIT PATTERN	Select from BURST 1, BURST 2, BURST 3, BURST 4, BURST 5, CHIRP 4, CHIRP 8, and RESERVE.
TRANSMIT count	In case operation mode is normal: Select from 8, 16, 32, 64, 128 and 256. In case operation mode is High Speed: Select from 4, 8, 16, 32, 64 and 128.
MEASURE METHOD	Select from METHOD 1, METHOD 2 and METHOD 3.
SATURATION	Enter in the range of numeric 0 to 512.
SIGNAL BALANCE	Enter in the range of numeric 0 to 100%.
SIGNAL PEEK	Select from 0.125 V (1024), 0.25 V (2048), 0.375 V (3072), and 0.5 V (4096).
TRIGGER LEVEL	With selection of AUTO/MANUAL, in case of MANUAL, input range of numeric 10.00 to 90.00% at right column.
WINDOW CONTROL	With selection of AUTO/MANUAL, in case of MANUAL, input range of numeric 1 to 16383 in each column of U: OPEN TIME/D: OPEN TIME.
AGC GAIN	With selection of AUTO/MANUAL, in case of MANUAL, input range of numeric 1.28 to 98.56% in each column of U: AGC/D: AGC.
TRANS. WAIT TIME	Enter in the range of numeric 5 to 30 msec.

## 9.14.2 Received Signal (optional function)

Click “RECEIVED SIGNAL”, and the following screen appears.

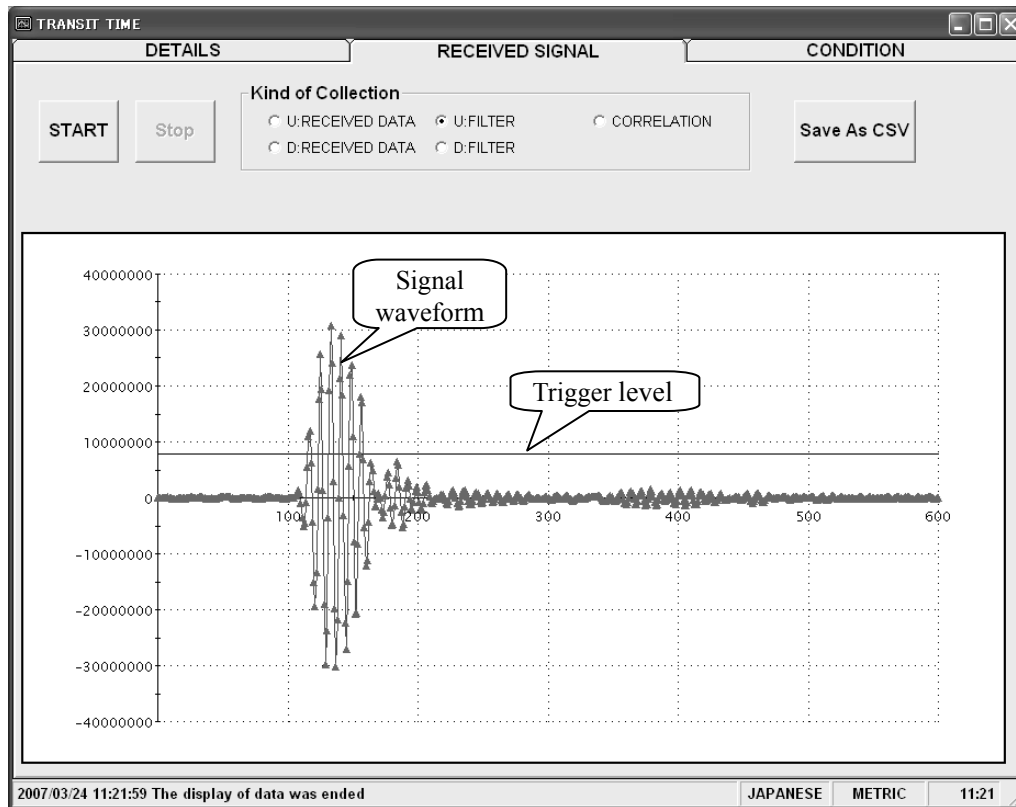

Fig. 9-22 < Received signal screen >

Select one from forward direction received wave, reverse direction received wave, forward direction filter, reverse direction filter and correlation waveform. Depending on measurement method (method 1, method 2 and method 3), items which can be selected vary as shown below. Trigger level is also displayed.

Left-click the mouse while pressing the shift key to specify the screen range, and the selected range is magnified. Press the R key to return to original status.

- Method 1: One from forward direction, reverse direction and correlation waveform can be selected.
- Method 2: One from forward direction, reverse direction, forward direction filter and reverse direction filter can be selected.
- Method 3: One from forward direction, reverse direction, forward direction filter and reverse direction filter can be selected.

[Start]..... Starts reading.

[Stop]..... Stops reading.

[Save As CSV] ..... Saves the measurement result in a file in CSV format. Click the button, and you are prompted to enter the name of a file to which the data is to be saved. Specify the destination to save and enter the file name, and a CSV file is created.

### Point

1. Startup is completed within 3 to 6 waves.
2. No peak (amplitude) fluctuation should be observed.  
Otherwise air is mixed in.

See “Checking send/receive” in “6. Maintenance and Inspection” of the separate instruction manual, “FIXED TYPE ULTRASONIC FLOWMETER” INF-TN2FSVG-E, for receive waveforms.

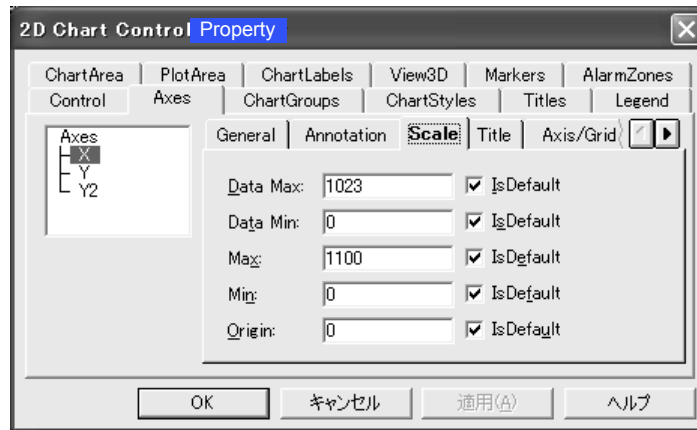

\* Right-click on the [Measurement] or [Receive waveform] screen, and scale can be adjusted.

### 9.14.3 Operation Information

Click “CONDITION”, and the following screen appears.

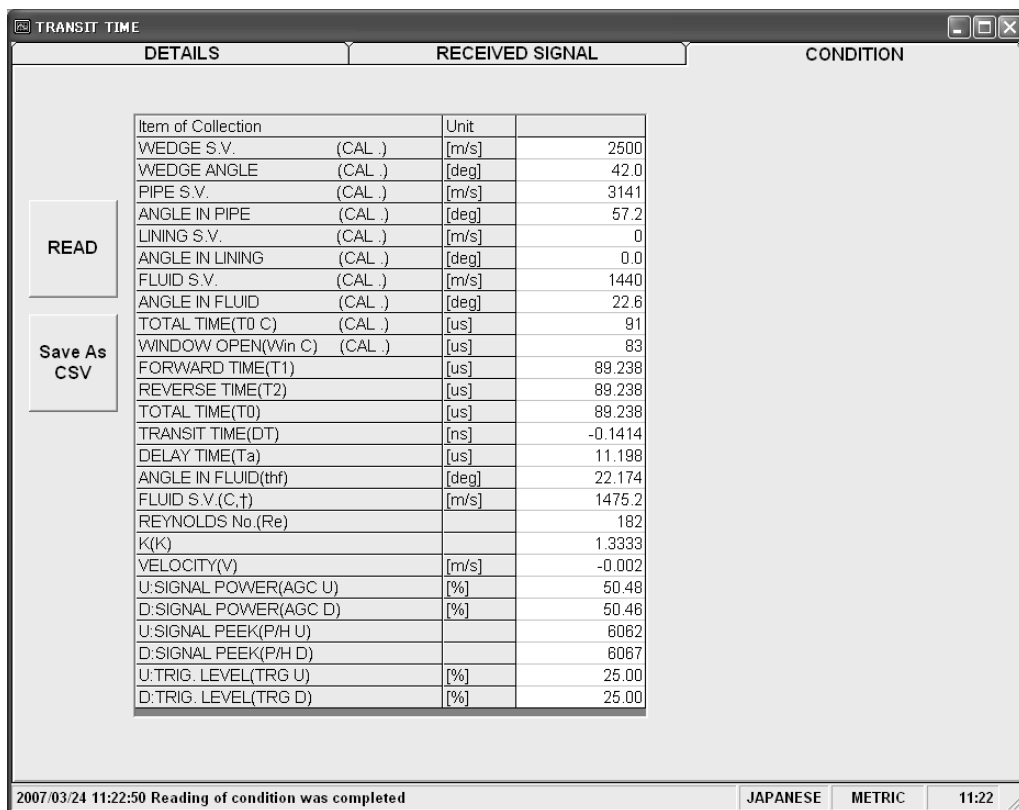

Fig. 9-23 < Operation Information screen >

Select either Line 1 or Line 2 first.

[Read].....Reads operation information in a batch.

[Save As CSV].....Saves Operation Information in file with CSV format. Click the button, and you are prompted to enter the name of a file to which the data is to be saved. Specify the destination to save and enter the file name, and a CSV file is created.

Table 9-17 &lt; Operation Information &gt;

Item	Content
WEDGE SOUND VELOCITY	m/s [ft/s]
WEDGE ANGLE	°
PIPE SOUND VELOCITY	m/s [ft/s]
ANGLE IN PIPE	°
LINING SOUND VELOCITY	m/s [ft/s]
ANGLE IN LINING	°
FLUID SOUND VELOCITY	m/s [ft/s]
ANGLE IN FLUID	°
TOTAL TIME	μs
WINDOW OPEN (Win C)	μs
FORWARD TIME	μs
RESERVE TIME	μs
TRANSIT TIME	ns
DELAY TIME	μs
FLUID SOUND VELOCITY	m/s [ft/s]
ANGLE IN FLUID	°
REINOLDS No. (Re)	
K	
VELOCITY	m/s [ft/s]
U: SIGNAL POWER (AGC U)	% * When measurement is normal: 35% or higher
D: SIGNAL POWER (AGC D)	% * When measurement is normal: 35% or higher
U: SIGNAL PEEK (P/H U)	* When measurement is normal: Stabilizes within the range from 5528 to 6758.
D: SIGNAL PEEK (P/H D)	* When measurement is normal: Stabilizes within the range from 5528 to 6758.
U: TRIG. LEVEL (TRG U)	%
D: TRIG. LEVEL (TRG D)	%

See “Displaying data in maintenance mode” in “6. Maintenance and Inspection” of the separate instruction manual, “FIXED TYPE ULTRASONIC FLOWMETER” INF-TN2FSVG-E, for the operation information.



# 9.15 RAS

Click the [RAS] button on the menu screen to display the RAS screen shown below.

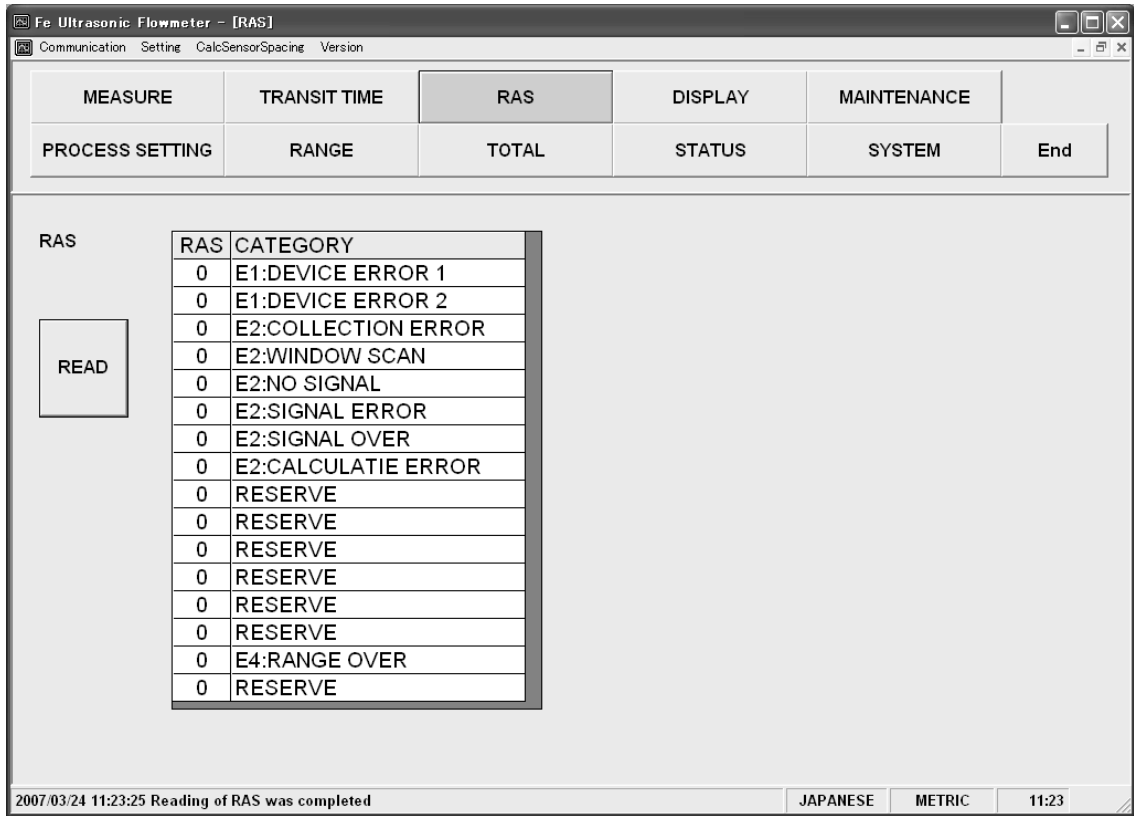

Fig. 9-24 < RAS screen >

[READ] button .....Displays RAS information (16 items from 0/1 to 0/16).

## 9.16 Maintenance

Click the “MAINTENANCE” button on the Menu screen, and the following screen appears.

Note: If [Setting] and [Read] are executed on this screen, the instrument is in the Maintenance mode for flowmeter.

Be sure to reset the Maintenance mode of flowmeter by clicking the [Release] button.

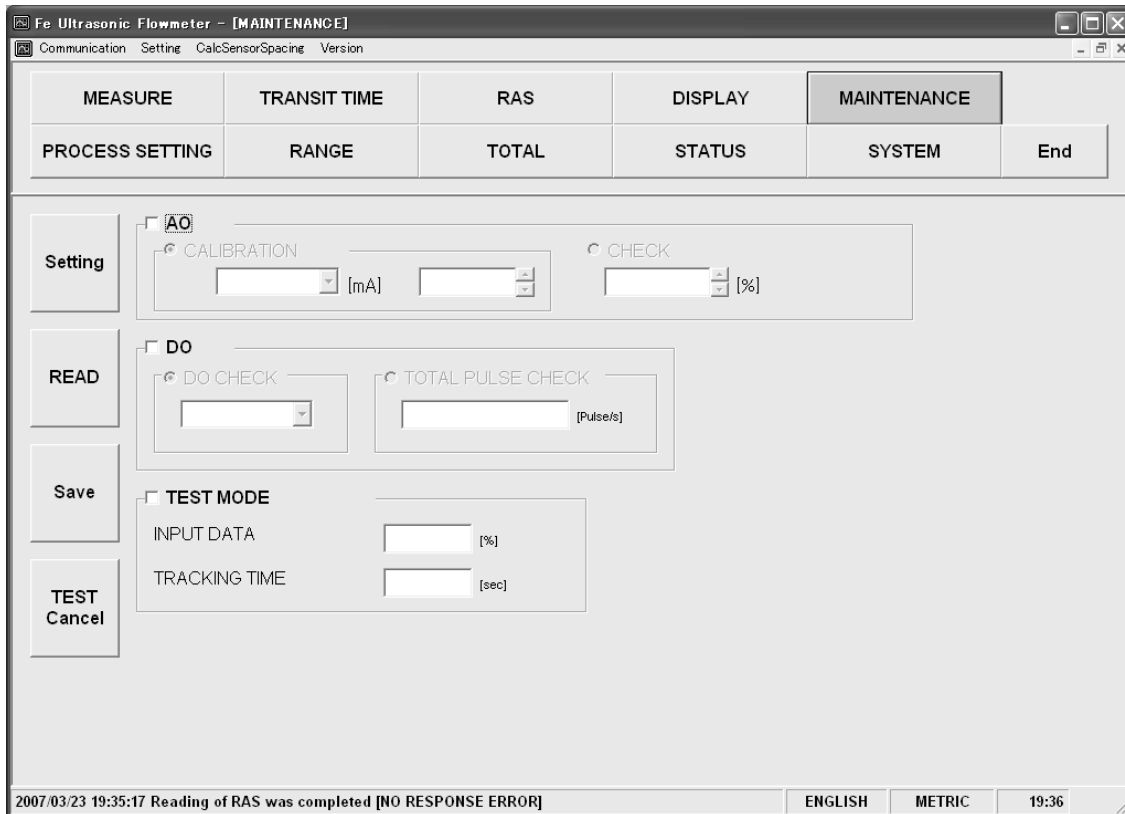

Fig. 9-25 < Maintenance screen >

Select the items to be set or read-in by checking the check box of the desired items (☑). Make the check box of the items not to be selected (or to be canceled) blank (☐).

See Table 9-18 on the next page for details of the maintenance.

[Setting] button..... Sends the setting of the selected items (☑) and reflects the response value to the setting.

[READ] button ..... Read-ins the setting of the selected items (☑) and reflects the response value to the setting.

[Save] button..... Reflects the setting sent by pressing the [Setting] button to the flow transmitter. Note that AO check, DO check, total pulse check, test mode, input data, and tracking time are not saved. Be sure to click the [Save] button if AO is adjusted.

[TEST Cancel] button . Cancels the AO/DO/Test mode.

\* Be sure to press the [TEST Cancel] button when maintenance is completed.

Table 9-18 < Maintenance/setting >

Item	Content
AO adjustment	When 4mA is selected, without decimal point, Enter in the range from 50 to 7148. When 20mA is selected, without decimal point, Enter in the range from 7148 to 15950.
AO check	Without decimal point, Enter in the range from -20 to 120%.
DO check	Select ON or OFF.
DO total pulse check	Without decimal point, Enter in the range from 1 to 100 Pulse/s.
Test mode	Check the check box ( <input checked="" type="checkbox"/> ) to enter the test mode. Exit the test mode if either input data or tracking time is entered and the check box is blank ( <input type="checkbox"/> ) .
Input data	Without decimal point, Enter in the $\pm 120\%$ range.
Tracking time	Without decimal point, Enter in the range from 0 to 900 sec.

## 9.17 PV

Click the [PV] button on the menu screen to display the PV screen (when RS-485 communication system is selected only).

### CAUTION

- The window cannot be moved on the PV screen.
- Do not start or operate other applications while measurement is in progress. Otherwise proper measurement cannot be obtained.

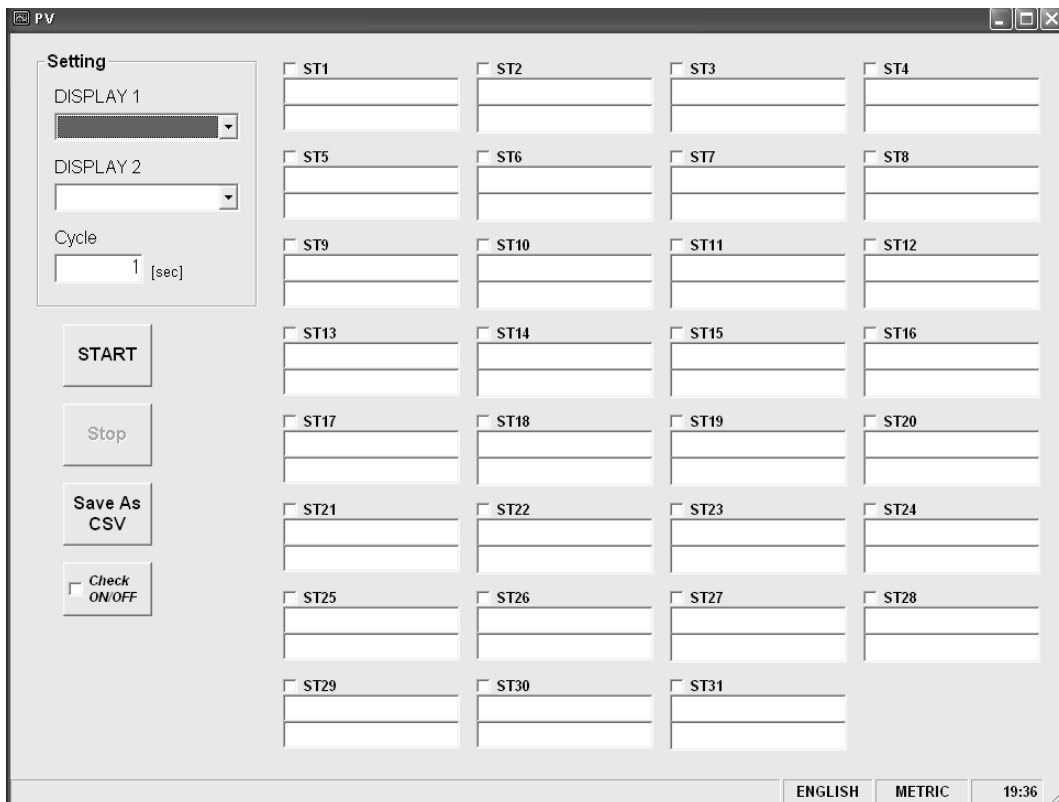

Fig. 9-26 < PV screen >

Select the station No. to be measured by checking the check box of the desired item (). Make the check box of the items not to be selected (or to be canceled) blank (.

The number of measurable units can be calculated by the following expression:

$$\text{Number of measurable units} = \text{Cycle (sec)} / 0.5 \text{ sec}$$

See Table 9-19 for details of PV.

- [START] button ..... Starts the measurement of the selected device (). When setting of saving file is completed with [Save as CSV] button, [Start] button will be enabled to click.
- [Stop] button ..... Stops the measurement.
- [Save as CSV] button ..Saves the measurement data of each device in a file in CSV format.

On clicking the button, you are asked where to save the data as well as the name of the file. Enter the place to save data and the name of the file, and a file in CSV format is created. When click the [Save as CSV], you are asked the file name where to save and then input the destination and file name to save, and file in CSV format will be created.

When setting of saving file is completed, [Start] button will be enabled to click. When the number of data in the saving file exceeds 32000 line, new file will be created separately.

Year, month, date, hour, minute, and second part of the file name will be changed when the file are updated automatically.

Note) When amount of the data to be saved on the file exceeds 32000 lines, new file will be created automatically.

Please make sure that PC hard disc has space to save the data.

e.g.) Setting of file name YYYYMMDDHHMMSS

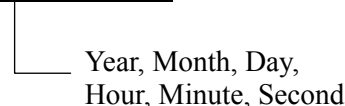

- [Check ON/OFF] check button ..... Check the check box () to select all the items. (The check boxes for all the items are checked ()). Keep the check box blank () to cancel the selection of all the items. (The check boxes for all the items are made blank ()).

Table 9-19 < PV Setting >

Item	Content
DISPLAY 1	Select from VELOCITY, FLOW RATE, + TOTAL (ACTUAL), – TOTAL (ACTUAL), + TOTAL PULSE, – TOTAL PULSE, RAS.
DISPLAY 2	Same as the selection of DISPLAY 1
CYCLE	Enter in range of 1 to 60 sec.

## 9.18 End

Click the [End] button on the Menu screen, and the following screen appears.

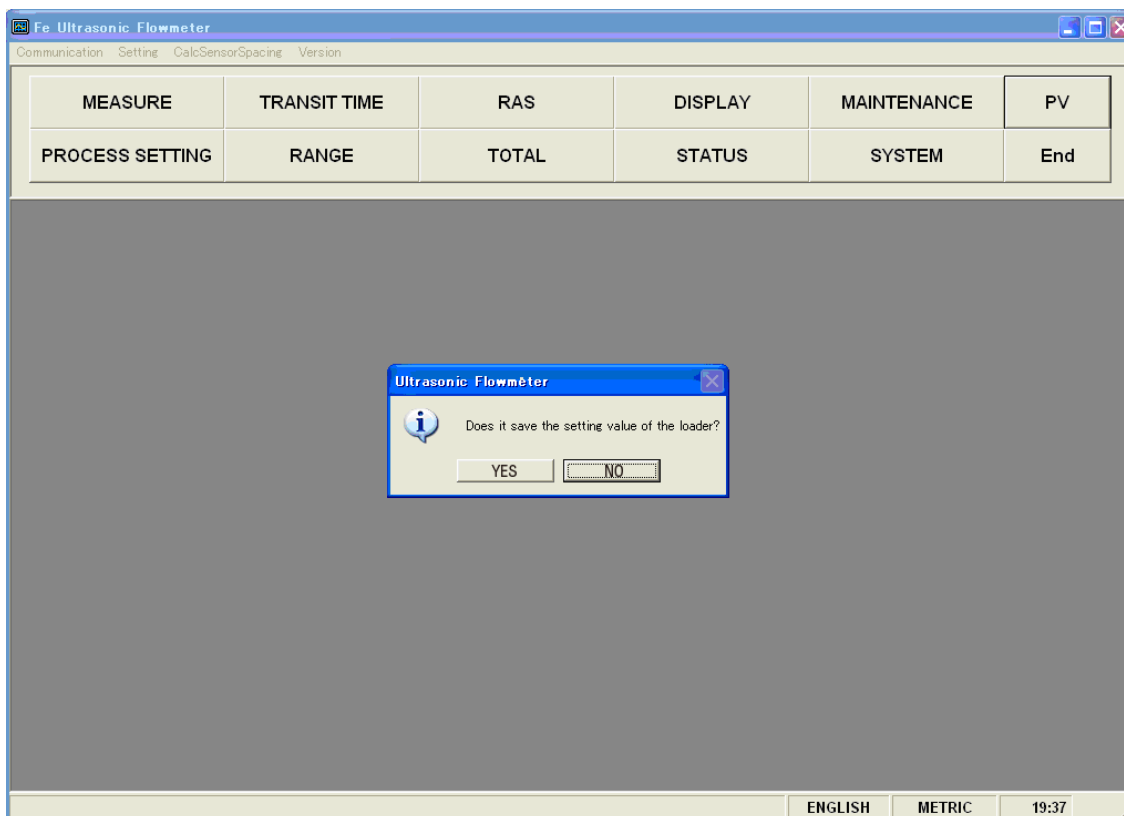

Fig. 9-27 < Menu screen >

Click either the [End] button or the (☒) button, and a message asking you whether you want to save the loader setting appears. To save setting value, select “Yes”. On the file designation window that appears, select a file, and the setting is saved in the file. Then the loader is terminated. Not to save setting value, select “No”, and the loader is terminated without saving the setting.

## 9.19 Uninstalling of Software

Select “Addition and Deletion of Application” from “Control Panel” of Windows, and click [Change and Deletion] to uninstall the software.

# 10. TROUBLESHOOTING

If the communication is unavailable, check the following items.

- Whether all devices related to communication are turned on.
- Whether connections are correct.
- Whether the number of connected instruments and connection distance are as specified.
- Whether communication conditions coincide between the master station (host computer) and slave stations.
  - Transmission speed:  9600bps  
 19200bps  
 38400bps
  - Data length: 8 bits
  - Stop bit: 1 bit
  - Parity:  odd  
 even  
 none
- Whether send/receive signal timing conforms to Section 5.3 in this manual.
- Whether the station No. designated as send destination by the master station coincides with the station No. of the connected FSV.
- Whether more than one instrument connected on the same transmission line shares the same station No.
- Whether the station No. of instruments is set at other than 0.  
If it is 0, the communication function does not work.
- Whether the 5th digit of type cord of this Flow transmitter is A ?  
(FSV□A□□2-□□□□□)

---

** Fuji Electric Co., Ltd.**

**International Sales Div  
Sales Group**

Gate City Ohsaki, East Tower, 11-2, Osaki 1-chome,  
Shinagawa-ku, Tokyo 141-0032, Japan  
<http://www.fujielectric.com>  
Phone: 81-3-5435-7280, 7281 Fax: 81-3-5435-7425  
<http://www.fujielectric.com/products/instruments/>

---